

AFS5500WH

---

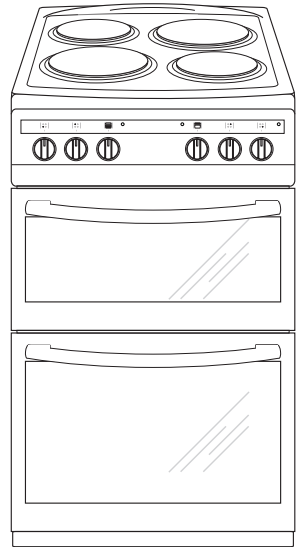

# INSTRUCTION MANUAL

---

ELECTRIC COOKER  
DOUBLE OVEN



IO-CFS-0522 / 8071310  
(02.2018 / v1)

---

## DEAR CUSTOMER,

---

*The cooker is exceptionally easy to use and extremely efficient. After reading the instruction manual, operating the cooker will be easy.*

*Before being packaged and leaving the manufacturer, the cooker was thoroughly checked with regard to safety and functionality.*

*Before using the appliance, please read the instruction manual carefully. By following these instructions carefully you will be able to avoid any problems in using the appliance.*

*It is important to keep the instruction manual and store it in a safe place so that it can be consulted at any time.*

*It is necessary to follow the instructions in the manual carefully in order to avoid possible accidents.*

### **Caution!**

*Do not use the cooker until you have read this instruction manual.*

*The cooker is intended for household use only.*

*The manufacturer reserves the right to introduce changes which do not affect the operation of the appliance.*

# TABLE OF CONTENTS

---

<b>Safety instructions</b> .....	4
<b>Description of the appliance</b> .....	8
<b>Installation</b> .....	10
<b>Operation</b> .....	12
<b>Baking in the oven – practical hints</b> .....	16
<b>Cleaning and maintenance</b> .....	18
<b>Technical data</b> .....	26

## SAFETY INSTRUCTIONS

---

**Warning:** The appliance and its accessible parts become hot during use. Care should be taken to avoid touching heating elements. Children less than 8 years of age shall be kept away unless continuously supervised.

This appliance can be used by children aged from 8 years and above and persons with reduced physical, sensory or mental capabilities or lack of experience and knowledge if they have been given supervision or instruction concerning use of the appliance in a safe way and understand the hazards involved. Children shall not play with the appliance. Cleaning and user maintenance shall not be made by children without supervision.

**Warning:** Unattended cooking on a hob with fat or oil can be dangerous and may result in fire.

NEVER try to extinguish a fire with water, but switch off the appliance and then cover flame e.g. with a lid or a fire blanket.

**Warning:** Danger of fire: do not store items on the cooking surfaces.

During use the appliance becomes hot. Care should be taken to avoid touching heating elements inside the oven.

Accessible parts may become hot during use. Young children should be kept away.

**Warning:** Do not use harsh abrasive cleaners or sharp metal scrapers to clean the oven door glass since they can scratch the surface, which may result in shattering of the glass.

## SAFETY INSTRUCTIONS

---

**Warning:** Ensure that the appliance is switched off before replacing the lamp to avoid the possibility of electric shock.

Before opening the cover, cleaning it of any dirt is recommended. The cooker hob surface should be cooled down before closing the cover.

You should not use steam cleaning devices to clean the appliance.

**Danger of burns!** Hot steam may escape when you open the oven door. Be careful when you open the oven door during or after cooking. Do NOT lean over the door when you open it. Please note that depending on the temperature the steam can be invisible.

- The appliance becomes hot during operation. Take care not to touch the hot parts inside the oven.
- Always keep children away from the cooker.  
While in operation direct contact with the cooker may cause burns!
- Ensure that small items of household equipment, including connection leads, do not touch the hot oven or the hob as the insulation material of this equipment is usually not resistant to high temperatures.
- Do not leave the cooker unattended when frying. Oils and fats may catch fire due to overheating or boiling over.
- Do not put pans weighing over 15 kg on the opened door of the oven and pans over 25 kg on the hob.
- Do not use harsh cleaning agents or sharp metal objects to clean the door as they can scratch the surface, which could then result in the glass cracking.
- Do not use the cooker in the event of a technical fault. Any faults must be fixed by an appropriately qualified and authorised person.
- In the event of any incident caused by a technical fault, disconnect the power and report the fault to the service centre to be repaired.
- The rules and provisions contained in this instruction manual should be strictly observed. Do not allow anybody who is not familiar with the contents of this instruction manual to operate the cooker.
- The appliance has been designed only for cooking. Any other use (for example for heating) does not comply with its operating profile and may cause danger.

## HOW TO SAVE ENERGY

---



Using energy in a responsible way not only saves money but also helps the environment. So let's save energy! And this is how you can do it:

- **Use proper pans for cooking.**

Pans with thick, flat bases can save up to 1/3 on electric energy. Remember to cover pans if possible otherwise you will use four times as much energy!

- **Match the size of the saucepan to the surface of the heating plate.**

A saucepan should never be smaller than a heating plate.

- **Ensure heating plates and pan bases are clean.**

Soils can prevent heat transfer – and repeatedly burnt-on spillages can often only be removed by products which cause damage to the environment.

- **Do not uncover the pan too often (a watched pot never boils!).**

Do not open the oven door unnecessarily often.

- **Switch off the oven in good time and make use of residual heat.**

For long cooking times, switch off heating plates 5 to 10 minutes before finishing cooking. This saves up to 20% on energy.

- **Only use the oven when cooking larger dishes.**

Meat of up to 1 kg can be prepared more economically in a pan on the cooker hob.

- **Make use of residual heat from the oven.**

If the cooking time is greater than 40 minutes switch off the oven 10 minutes before the end time.

**Important!** When using the timer, set appropriately shorter cooking times according to the dish being prepared.

- **Make sure the oven door is properly closed.**

Heat can leak through spillages on the door seals. Clean up any spillages immediately.

- **Do not install the cooker in the direct vicinity of refrigerators/freezers.**

Otherwise energy consumption increases unnecessarily.

## UNPACKING



During transportation, protective packaging was used to protect the appliance against any damage. After unpacking, please dispose of all elements of packaging in a way that will

not cause damage to the environment.

All materials used for packaging the appliance are environmentally friendly; they are 100% recyclable and are marked with the appropriate symbol.

Caution! During unpacking, the packaging materials (polythene bags, polystyrene pieces, etc.) should be kept out of reach of children.

## DISPOSAL OF THE APPLIANCE



Old appliances should not simply be disposed of with normal household waste, but should be delivered to a collection and recycling centre for electric and electronic equipment. A symbol

shown on the product, the instruction manual or the packaging shows that it is suitable for recycling.

Materials used inside the appliance are recyclable and are labelled with information concerning this. By recycling materials or other parts from used devices you are making a significant contribution to the protection of our environment.

Information on appropriate disposal centres for used devices can be provided by your local authority.

## DESCRIPTION OF THE APPLIANCE

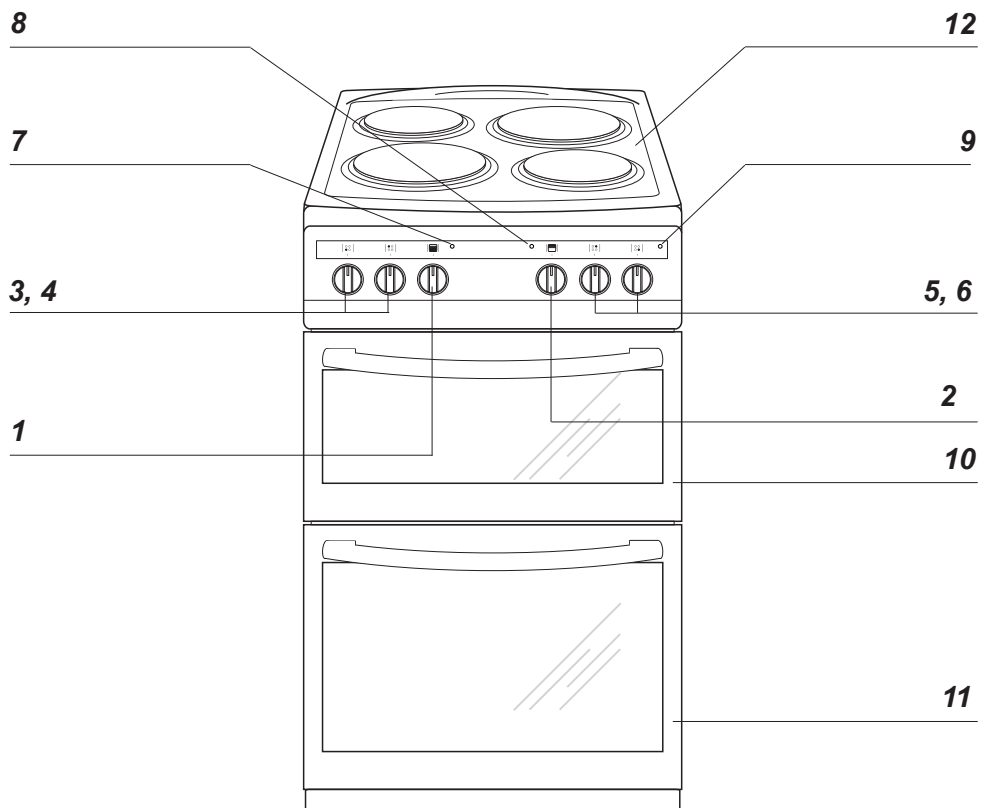

- 1** Temperature control knob - main oven
- 2** Temperature control knob - top oven
- 3, 4, 5, 6** Heating plate control knobs
- 7** Red thermostat light - main oven
- 8** Red thermostat light - top oven
- 9** Yellow operation light
- 10** Top oven door
- 11** Main oven door
- 12** Electric hob



# SPECIFICATIONS OF THE APPLIANCE

---

Cooker fittings:

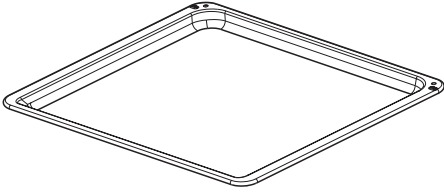

*Baking tray*

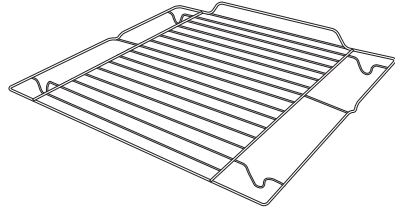

*Wire Shelf*

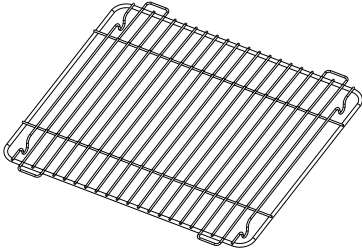

*Grill Rack*

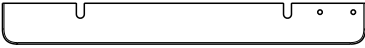

*Cover Knobs*

\*All images are for indication only; please refer to your individual unit for actual item.

# INSTALLATION

## Installing the cooker

- The kitchen should be dry and airy and have effective ventilation according to the existing technical provisions.
- The room should be equipped with a ventilation system that pipes away exhaust fumes created during combustion. This system should consist of a ventilation grid or hood. Hoods should be installed according to the manufacturer's instructions. The cooker should be placed so as to ensure free access to all control elements.
- Coating or veneer used on fitted furniture must be applied with a heat resistant adhesive (100°C). This prevents surface deformation or detachment of the coating. If you are unsure of your furniture's heat resistance, you should leave approximately 2 cm of free space around the cooker. The wall behind the cooker should be resistant to high temperatures. During operation, its back side can warm up to around 50°C above the ambient temperature.
- The cooker should stand on a hard, even floor (do not put it on a base).
- Before you start using the cooker it should be leveled, which is particularly important for fat distribution in a frying pan. To this purpose, adjustable feet are accessible after removal of the drawer. The adjustment range is +/- 5 mm.

## Anti-tilt protection

**CAUTION!** You must install the anti-tilt protection. If you do not install it, the appliance can tilt.

The appliance must be secured by using the safety chain (supplied and mounted to cooker rear).

Fasten hook to the kitchen wall and connect safety chain to the hook.

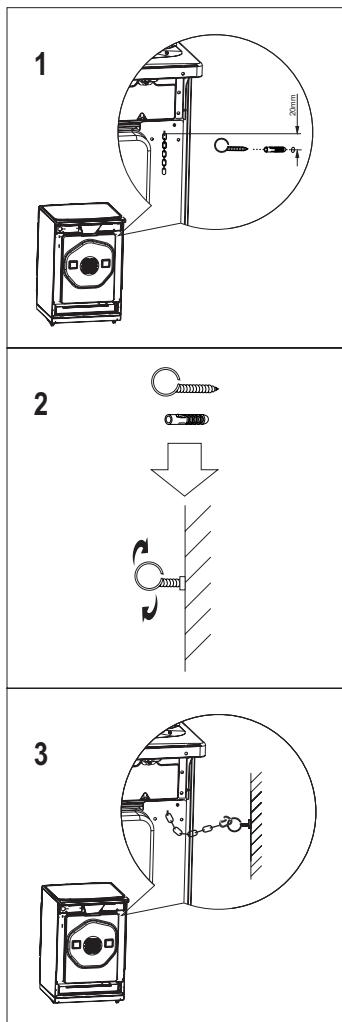

# INSTALLATION

## Electrical connection

**Warning:** This appliance must be earthed.

The appliance must be installed by a competent electrician using a double pole control unit of 40 ampere minimum capacity with 3 mm minimum contact separation at all poles.

We recommend that the appliance is connected by a qualified electrician who is member of the N.C.E.I.C. and who will comply with the I.E.E. and local regulation.

- Access to the main terminal is gained by opening the terminal block cover at the rear of the appliance (use a small flat-bladed screwdriver).
- Connection should be made with 4 mm<sup>2</sup> twin and earth cable.
- First strip the wires, then push the cable through the cable clamp in the terminal block cover.
- Connect the cable to the terminal block and tighten the cable clamp screw (see diagram).
- Ensure the cable exits through the cable grip clamping on the outer sheath of the cable and fix in place by tightening the fixing screw.
- Ensure all screws are adequately tightened. Do not over tighten as you may risk damaging the screw threads.
- Close the terminal box, ensuring that the cover is engaged on the locking tabs.
- The supply cable must be positioned away from any hot parts of the rear of the appliance. If this cannot be done then another method of protecting the supply cable from the hot parts must be used i.e. Heat resistant sleeving or high temperature cables.

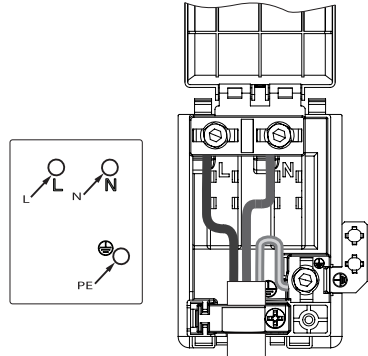

**220-240V 1N~**

L - Live (Red or Brown)  
N - Neutral (Black or Blue)  
PE - Earth (Green/Yellow or sleeving)

Grounding lead must be connected to screw with  symbol.

The power supply cable must have these minimum requirements:

- Type: HO5VV-F (PVC insulated and sheathed flexible cable)
- 3 cores x 4 mm<sup>2</sup> .

## OPERATION

---

### Before first use

- Remove packaging, clean the interior of the oven and the hob.
- Take out and wash the oven fittings with warm water and a little washing-up liquid.
- Switch on the ventilation in the room or open a window.
- Heat the oven (to a temperature of 250°C, for approx. 30 min.), remove any stains and wash carefully; the heating plates of the hob should be heated for around 4 min. without a pan.

# OPERATION

## How to use the heating plate

The level of heat can be adjusted gradually by turning the appropriate knob to the right or left. Switching on the plate results in a yellow signal light on the control panel turning on.

An appropriately selected pan saves energy. A pan should have a thick, flat base with a diameter equal to the plate diameter, as in that case heat is transferred most efficiently.



- 0 Switch off
- MIN. Warming up
- 1 Stewing vegetables, slow cooking
- Cooking soups, larger dishes
- 2 Slow frying
- Grilling meat, fish
- 3 MAX. Fast heating up, fast cooking, frying

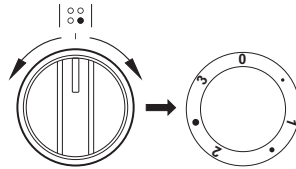

**Do not switch on heating plate until the pan has been placed on it.**

### Caution!

Ensure the plate is clean – a soiled zone does not transfer all of the heat.

Protect the plate against corrosion.

Switch off the plate before a pan is removed.

Do not leave pans with prepared dishes based on fats and oils unattended on the switched – on plate; hot fat can spontaneously catch fire.

# OPERATION

## Top oven functions and operations

### Natural convection oven (conventional).

The oven can be warmed up using the bottom and top heaters, as well as the grill. Operation of the oven is controlled by the temperature regulator knob.

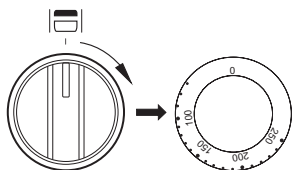

### Oven on and off

In order to switch on the oven you need to:

- set required working conditions of the oven, its temperature and a mode of heating,
- set the knob to the required position, turning it right.

Switching on the oven is indicated by two signal lights, yellow and red, turning on. The yellow light turned on means the oven is working. If the red light goes out, it means the oven has reached the set temperature. If a recipe recommends placing dishes in a warmed-up oven, this should be not done before the red light goes out for the first time. When baking, the red light will temporarily come on and go out (to maintain the temperature inside the oven). Switching off the oven – in order to switch off the oven, set the knob to the “0” knob position, turning it left. The signal light should go out.

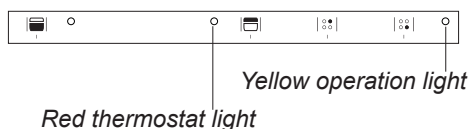

### Top and bottom heaters on, the oven door is closed.

**100-250 °C** The thermostat enables the user to set the temperature within a range from 100°C to 250°C. Use for baking. This setting is ideal for baking cakes, meat, fish, bread and pizza (it is necessary to preheat the oven and use a baking tray) on one oven level.

### Grill on, the oven door is open.

**100-250 °C** The thermostat enables the user to set the temperature within a range from 100°C to 250°C. Grilling is used for cooking of small portions of meat: steaks, schnitzel, fish, toasts, Frankfurter sausages, (thickness of roasted dish should not exceed 2-3 cm and should be turned over during roasting). For grilling with the function grill the temperature must be set to 250°C.

### Warning!

The door of the oven should be open while grilling. Put the knob cover on.

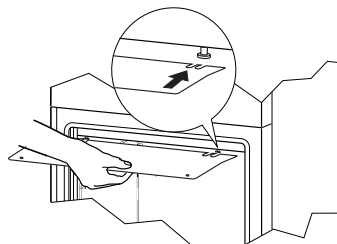

Accessible parts may become hot during use. Young children should be kept away.

# OPERATION

## Main oven functions and operations

### Oven with automatic air circulation.

The oven can be warmed up using the ring heating element and rotating fan. Operation of the oven is controlled by the temperature regulator knob.

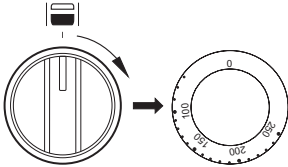

### Oven on and off

In order to switch on the oven you need to:

- set required working conditions of the oven, its temperature and a mode of heating,
- set the knob to the required position, turning it right.

Switching on the oven is indicated by two signal lights, yellow and red, turning on. The yellow light turned on means the oven is working. If the red light goes out, it means the oven has reached the set temperature. If a recipe recommends placing dishes in a warmed-up oven, this should be not done before the red light goes out for the first time. When baking, the red light will temporarily come on and go out (to maintain the temperature inside the oven). Switching off the oven – in order to switch off the oven, set the knob to the “0” knob position, turning it left. The signal light should go out.



### Convection with ring heating element

100-250  
°C

The thermostat enables the user to set the temperature within a range from 100°C to 250°C. The oven is heated up by a heating element with air circulation forced by a rotating fan fitted in the central part of the back wall of the chamber. Lower baking temperatures than in the conventional oven can be used.

Heating the oven up in this manner ensures uniform heat circulation around the dish being cooked in the oven.



### Independent oven lighting

The main oven lamp will be switched on after the temperature has been set by the temperature regulator knob.

## BAKING IN THE OVEN – PRACTICAL HINTS

---

### Baking

- we recommend using the accessories which were provided with your cooker;
- it is also possible to bake in cake tins and trays bought elsewhere which should be put on the drying rack; for baking it is better to use black trays which conduct heat better and shorten the baking time;
- shapes and trays with bright or shiny surfaces are not recommended when using the conventional heating method (top and bottom heaters), use of such tins can result in undercooking the base of cakes;
- when using the ultra-fan function it is not necessary to initially heat up the oven chamber, for other types of heating you should warm up the oven chamber before the cake is inserted;
- before the cake is taken out of the oven, check if it is ready using a wooden stick (if the cake is ready the stick should come out dry and clean after being inserted into the cake);
- after switching off the oven it is advisable to leave the cake inside for about 5 min.;
- temperatures for baking with the ultra-fan function are usually around 20 – 30 degrees lower than in normal baking (using top and bottom heaters);
- the baking parameters given in Table are approximate and can be corrected based on your own experience and cooking preferences;
- if information given in recipe books is significantly different from the values included in this instruction manual, please apply the instructions from the manual.















### Roasting meat

- cook meat weighing over 1 kg in the oven, but smaller pieces should be cooked on the gas burners.
- use heatproof ovenware for roasting, with handles that are also resistant to high temperatures;
- when roasting on the drying rack or the grate we recommend that you place a baking tray with a small amount of water on the lowest level of the oven;
- it is advisable to turn the meat over at least once during the roasting time and during roasting you should also baste the meat with its juices or with hot salty water – do not pour cold water over the meat.















# BAKING IN THE OVEN – PRACTICAL HINTS

## Natural convection oven (conventional)

Type of dish	Oven functions	Temperature °C	Level ( $\begin{matrix} 4 \\   \\ 1 \end{matrix}$ )	Time in minutes 
		160 - 200	2 - 3	30 - 50
		160 - 180	2	20 - 40*
		210 - 220	2	45 - 60
		225 - 250	2	120 - 150
		160 - 230	2	90 - 120
		160 - 180	2	45 - 60
		190 - 210	2	40 - 50

## Oven with automatic air circulation (including a fan and an ultra-fan heater)

Type of dish	Oven functions	Temperature °C	Level ( $\begin{matrix} 4 \\   \\ 1 \end{matrix}$ )	Time in minutes 
		140 - 160	2	10 - 40*
		200 - 230	1 - 3	10 - 20
		160 - 180	2 - 3	45 - 60
		160 - 180	2	120 - 160
		160 - 190	2	90 - 120
		175 - 190	2	60 - 70

\* Baking smaller items

### Caution!

The figures given in Tables are approximate and can be adapted based on your own experience and cooking preferences.

## CLEANING AND MAINTENANCE

---

By ensuring proper cleaning and maintenance of your cooker you can have a significant influence on the continuing fault-free operation of your appliance.

**Before you start cleaning, the cooker must be switched off and you should ensure that all knobs are set to the “●”/“0” position. Do not start cleaning until the cooker has completely cooled.**

### Electric hob

From time to time a lukewarm heating plate should be covered with a thin layer of an available lubricating agent. It is recommended to use engine oil applied for sewing machines or bicycles. Do not apply edible oil, because its salt contents may damage the plates. Dried up spillage on the surface or rim of the plates should be removed with a dry pad or brush.

Do not use abrasives, because they may cause the forming of rust on the plates. By no means rub the plates with abrasive paper.

Take care not to let salt drop on the plates. It dissolves in water producing ugly rust spots. Use only dry pots and do not put wet lids on the plates. The enamel parts of the cooker can be wiped with a gentle rinsing solution and dried with a soft cloth. Spillage can be wiped during cooking with a dry cloth, to prevent building up of hard to clean burnt deposits.

Chrome plated parts (e.g. rings around heating plates can be easily polished with a soft cloth).

# CLEANING AND MAINTENANCE

---

## Oven

- The oven should be cleaned after every use. When cleaning the oven the lighting should be switched on to enable you to see the surfaces better.
- The oven chamber should only be washed with warm water and a small amount of washing-up liquid.

### Caution!

Do not use cleaning products containing abrasive materials for the cleaning and maintenance of the glass front panel.

## Replacement of the oven light bulb

**In order to avoid the possibility of an electric shock ensure that the appliance is switched off before replacing the bulb.**

- Set all control knobs to the position “●”/“0” and disconnect the mains plug,
- unscrew and wash the lamp cover and then wipe it dry.
- unscrew the light bulb from the socket, replace the bulb with a new one – a high temperature bulb (300°C) with the following parameters:
  - voltage 230 V
  - power 25 W
  - thread E14.

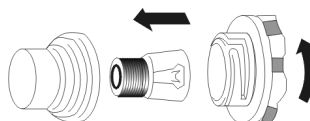

- Screw the bulb in, making sure it is properly inserted into the ceramic socket.
- Screw in the lamp cover.

# CLEANING AND MAINTENANCE

## Removing the Top Oven Door

In order to obtain easier access to the oven chamber for cleaning, it is possible to remove the door. To do this, tilt the safety catch part of the hinge upwards (fig. A). Close the door lightly, lift and pull it out towards you. In order to fit the door back on to the cooker, do the inverse. When fitting, ensure that the notch of the hinge is correctly placed on the protrusion of the hinge holder. After the door is fitted to the oven, the safety catch should be carefully lowered down again. If the safety catch is not set it may cause damage to the hinge when closing the door.

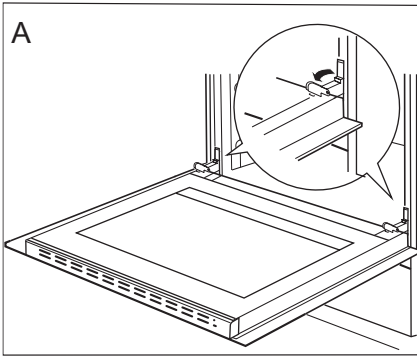

*Tilting the hinge safety catches*

## Removing the inner panel

1. Using a flat screwdriver unhook the upper door slat, prying it gently on the sides (fig. B).
2. Pull the upper door slat loose. (fig. B, C)

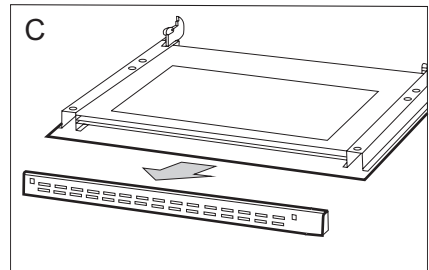
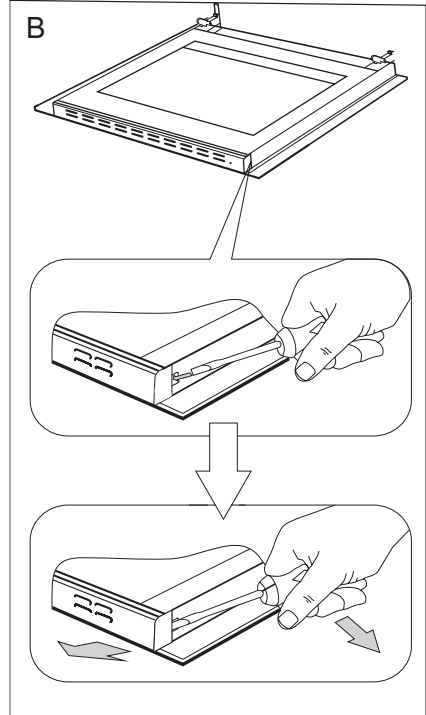

## CLEANING AND MAINTENANCE

3. Pull the inner glass panel from its seat (in the lower section of the door). Remove the inner panel (fig. D, D1).
4. Clean the panel with warm water with some cleaning agent added.  
Carry out the same in reverse order to reassemble the inner glass panel. Its smooth surface shall be pointed upwards.

**Important! Do not force the upper strip in on both sides of the door at the same time.** In order to correctly fit the top door strip, first put the left end of the strip on the door and then press the right end in until you hear a “click”. Then press the left end in until you hear a “click”.

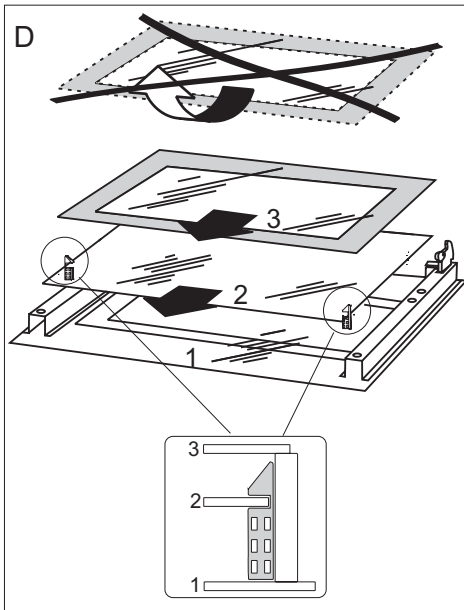

*Removal of the internal glass panel.  
3 glass panel.*

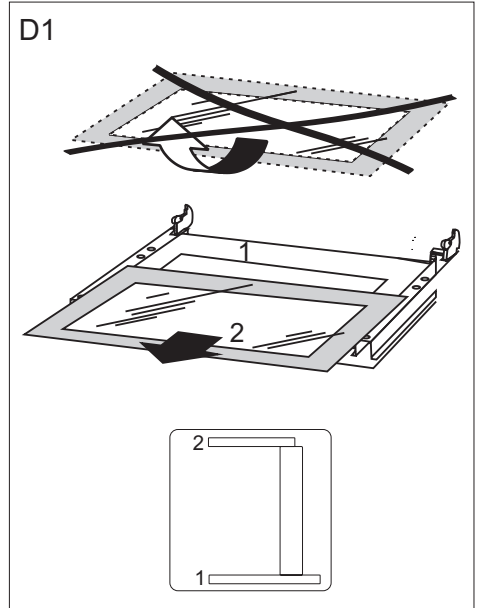

*Removal of the internal glass panel.  
2 glass panel.*

## CLEANING AND MAINTENANCE

---

### Regular inspections

Besides keeping the cooker clean, you should:

- carry out periodic inspections of the control elements and cooking units of the cooker. After the guarantee has expired you should have a technical inspection of the cooker carried out at a service centre at least once every two years,
- fix any operational faults,
- carry out periodical maintenance of the cooking units of the cooker.

### Caution!

All repairs and regulatory activities should be carried out by the appropriate service centre or by an appropriately authorised fitter.

## OPERATION IN CASE OF EMERGENCY

---

In the event of an emergency, you should:

- switch off all working units of the cooker
- disconnect the mains plug
- call the service centre
- some minor faults can be fixed by referring to the instructions given in the table below. Before calling the customer support centre or the service centre check the following points that are presented in the table.

PROBLEM	REASON	ACTION
1. The appliance does not work.	Break in power supply.	Check the household fuse box; if there is a blown fuse replace it with a new one.
2. The oven lighting does not work.	The bulb is loose or damaged.	Tighten up or replace the blown bulb (see ' <i>Cleaning and Maintenance</i> ').

## PRODUCT FICHE

The information in the product data sheet is given in accordance with the Commission delegated Regulation (EU) No 65/2014 supplementing Directive of the European Parliament and of the Council 2010/30/EU with regard to energy labelling of household ovens and range hoods

A	Supplier name	Amica S.A.
B1	Model identifier	AFS5500WH
B2		507DEE2.20HmOFQW
B3		56348
C	Energy efficiency index of top cavity (EEI cavity)	106,9
C'	Energy efficiency index of main cavity (EEI cavity)	106,1
D	Energy efficiency class of top cavity	A
D'	Energy efficiency class of main cavity	A
E	Energy consumption per cycle of top cavity (EC electric cavity)	0,77 -
E1	conventional mode [kWh]	
E2	fan-forced mode [kWh]	
E'	Energy consumption per cycle of main cavity (EC electric cavity)	- 0,87
E1'	conventional mode [kWh]	
E2'	fan-forced mode [kWh]	
F	Number of cavities	2
G	Heat source of top cavity (electricity or gas)	V / O
G'	Heat source of main cavity (electricity or gas)	V / O
H	Cavity volume [l] - top	41
H'	Cavity volume [l] - main	64

**In order to determine compliance with the eco-design requirements, the measurement methods and calculations of the following standards were applied:**

EN 60350-1

EN 60350-2

# PRODUCT INFORMATION

Product information given in accordance with Commission Regulation (EU) No 66/2014 supplementing Directive of the European Parliament and Council Directive 2009/125/EC with regard to eco-design requirements for household ovens, hobs and range hoods

## Household ovens

I1		AFS5500WH
I2	Model identifier	507DEE2.20HmOFQW
I3		56348
J	Oven type (electricity or gas) - top	V / O
J'	Oven type (electricity or gas) - main	V / O
K	Appliance weight [kg]	45,0
L	Number of cavities	2
M	Source of heat for each cavity (electricity or gas) - top	V / O
M'	Source of heat for each cavity (electricity or gas) - main	V / O
N	Volume of each cavity V [l] - top	41
N	Volume of each cavity V [l] - main	64
O	Energy consumption needed to heat a standard charge in an electric oven cavity during a single cycle in conventional mode for each cavity (final electric energy consumption) EC electric cavity [kWh/cycle] - top	0,77
O'	Energy consumption needed to heat a standard charge in an electric oven cavity during a single cycle in conventional mode for each cavity (final electric energy consumption) EC electric cavity [kWh/cycle] - main	-
P	Energy consumption needed to heat a standard charge in an electric oven cavity during a single cycle in fan-forced mode for each cavity (final electric energy consumption) EC electric cavity [kWh/cycle] - top	-
P'	Energy consumption needed to heat a standard charge in an electric oven cavity during a single cycle in fan-forced mode for each cavity (final electric energy consumption) EC electric cavity [kWh/cycle] - main	0,87
Q	Energy efficiency index EEI cavity for each cavity - top	106,9
Q'	Energy efficiency index EEI cavity for each cavity - main	106,1



# PRODUCT INFORMATION

Product information given in accordance with Commission Regulation (EU) No 66/2014 supplementing Directive of the European Parliament and Council Directive 2009/125/EC with regard to eco-design requirements for household ovens, hobs and range hoods

## Household electric hobs

R1			AFS5500WH
R2	Model identifier		507DEE2.20HmOFQW
R3			56348
S		Hob type (electric / gas / gas-electric)	V / O / O
T	Number of cooking zones		4
U	Heating technique (induction cooking zones or heating areas, radiant heating zones, solid hobs)		O / O / V
V1	Usable surface diameter for electric cooking zone rounded to 5 mm [Ø cm]	FL	Ø 18,0
V2		RL	Ø 14,5
V3		RR	Ø 18,0
V4		FR	Ø 14,5
W1	Energy consumption for each cooking zone per kg, EC electric cooking [Wh/kg]	FL	198,9
W2		RL	198,9
W3		RR	198,9
W4		FR	198,9
X	Energy consumption by the hob per kg EC electric hob [Wh/kg]		198,9

## TECHNICAL DATA

Model	AFS5500WH
Rated Voltage	220-240V~
Rated Frequency	50 Hz
Power	9500 W
Electric hob	5500 W
Top oven	2000 W
Top heater	500 W
Bottom heater	1000 W
Grill	2000 W
Main oven	1900 W
Ring element	2000 W
External Dimensions (H x W x D)	500(W) x 600(D) x 900(H) mm

### *Certificate of compliance CE*

*The Manufacturer hereby declares that this product complies with the general requirements pursuant to the following European Directives:*

- *The Low Voltage Directive 2014/35/EC,*
- *Electromagnetic Compatibility Directive 2014/30/EC,*
- *ErP Directive 2009/125/EC,*

*and therefore the product has been marked with the **CE** symbol and the **Declaration of Conformity** has been issued to the manufacturer and is available to the competent authorities regulating the market.*



---