

# Amica

10143.3ETsDbHaScJQaW  
10143.3ETsDbHaScJQaS

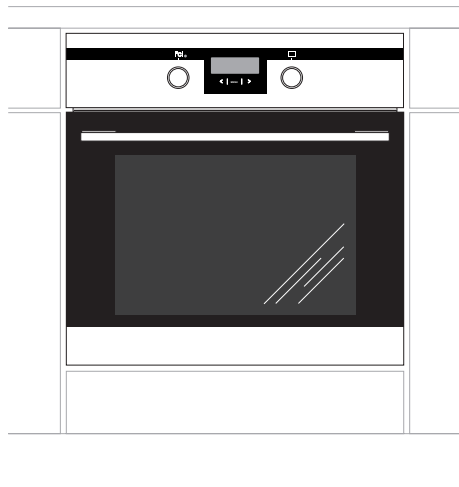

## INSTRUCTION MANUAL

### BUILT-IN ELECTRIC OVEN

## DEAR CUSTOMER,

---

*The oven is exceptionally easy to use and extremely efficient. After reading the instruction manual, operating the oven will be easy.*

*Before being packaged and leaving the manufacturer, the oven was thoroughly checked with regard to safety and functionality.*

*Before using the appliance, please read the instruction manual carefully. By following these instructions carefully you will be able to avoid any problems in using the appliance.*

*It is important to keep the instruction manual and store it in a safe place so that it can be consulted at any time.*

*It is necessary to follow the instructions in the manual carefully in order to avoid possible accidents.*

### **Caution!**

*Do not use the oven until you have read this instruction manual.*

*The oven is intended for household use only.*

*The manufacturer reserves the right to introduce changes which do not affect the operation of the appliance.*

# TABLE OF CONTENTS

---

<b>Safety instructions</b> .....	4
<b>Description of the appliance</b> .....	7
<b>Installation</b> .....	10
<b>Operation</b> .....	12
<b>Baking in the oven – practical hints</b> .....	19
<b>Cleaning and maintenance</b> .....	21
<b>Technical data</b> .....	26

## SAFETY INSTRUCTIONS

---

**Warning:** The appliance and its accessible parts become hot during use. Care should be taken to avoid touching heating elements. Children less than 8 years of age shall be kept away unless continuously supervised.

This appliance can be used by children aged from 8 years and above and persons with reduced physical, sensory or mental capabilities or lack of experience and knowledge if they have been given supervision or instruction concerning use of the appliance in a safe way and understand the hazards involved. Children shall not play with the appliance. Cleaning and user maintenance shall not be made by children without supervision.

During use the appliance becomes hot. Care should be taken to avoid touching heating elements inside the oven.

Accessible parts may become hot during use. Young children should be kept away.

**Warning:** Do not use harsh abrasive cleaners or sharp metal scrapers to clean the oven door glass since they can scratch the surface, which may result in shattering of the glass.

## SAFETY INSTRUCTIONS

---

**Warning:** Ensure that the appliance is switched off before replacing the lamp to avoid the possibility of electric shock.

You should not use steam cleaning devices to clean the appliance.

- Ensure that small items of household equipment, including connection leads, do not touch the hot oven as the insulation material of this equipment is usually not resistant to high temperatures.
- Do not leave the oven unattended when frying. Oils and fats may catch fire due to overheating or boiling over.
- Do not put pans weighing over 15 kg on the opened door of the oven.
- Do not use harsh cleaning agents or sharp metal objects to clean the door as they can scratch the surface, which could then result in the glass cracking.
- Do not use the oven in the event of a technical fault. Any faults must be fixed by an appropriately qualified and authorised person.
- In the event of any incident caused by a technical fault, disconnect the power and report the fault to the service centre to be repaired.
- The rules and provisions contained in this instruction manual should be strictly observed. Do not allow anybody who is not familiar with the contents of this instruction manual to operate the oven.
- The appliance has been designed only for cooking. Any other use (for example for heating) does not comply with its operating profile and may cause danger.

## HOW TO SAVE ENERGY

---



Using energy in a responsible way not only saves money but also helps the environment. So let's save energy! And this is how you can do it:

- **Do not uncover the pan too often (a watched pot never boils!).**

Do not open the oven door unnecessarily often.

- **Switch off the oven in good time and make use of residual heat.**

For long cooking times, switch off heating zones 5 to 10 minutes before finishing cooking. This saves up to 20% on energy.

- **Only use the oven when cooking larger dishes.**

Meat of up to 1 kg can be prepared more economically in a pan on the cooker hob.

- **Make use of residual heat from the oven.**

If the cooking time is greater than 40 minutes switch off the oven 10 minutes before the end time.

**Important!** When using the timer, set appropriately shorter cooking times according to the dish being prepared.

- **Make sure the oven door is properly closed.**

Heat can leak through spillages on the door seals. Clean up any spillages immediately.

- **Do not install the oven in the direct vicinity of refrigerators/freezers.**

Otherwise energy consumption increases unnecessarily.

## UNPACKING



During transportation, protective packaging was used to protect the appliance against any damage. After unpacking, please dispose of all elements of packaging in a way that will not cause damage to the environment.

All materials used for packaging the appliance are environmentally friendly; they are 100% recyclable and are marked with the appropriate symbol.

Caution! During unpacking, the packaging materials (polythene bags, polystyrene pieces, etc.) should be kept out of reach of children.

## DISPOSAL OF THE APPLIANCE



Old appliances should not simply be disposed of with normal household waste, but should be delivered to a collection and recycling centre for electric and electronic equipment. A symbol shown on the product, the instruction manual or the packaging shows that it is suitable for recycling.

Materials used inside the appliance are recyclable and are labelled with information concerning this. By recycling materials or other parts from used devices you are making a significant contribution to the protection of our environment.

Information on appropriate disposal centres for used devices can be provided by your local authority.

## DESCRIPTION OF THE APPLIANCE

---

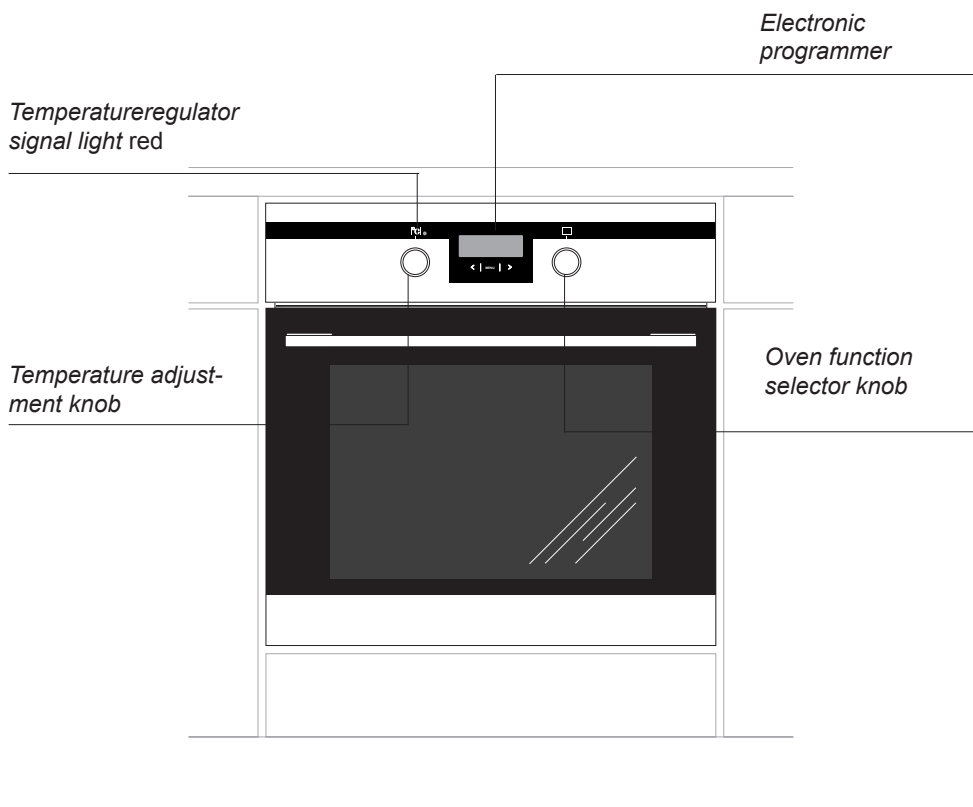



## SPECIFICATIONS OF THE APPLIANCE

---

Cooker fittings:

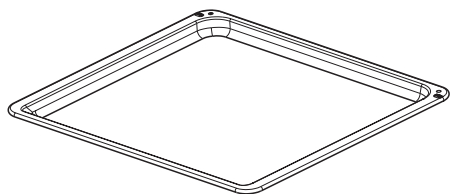

*Baking tray\**

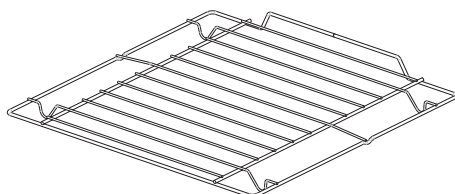

*Grill grate  
(drying rack)*

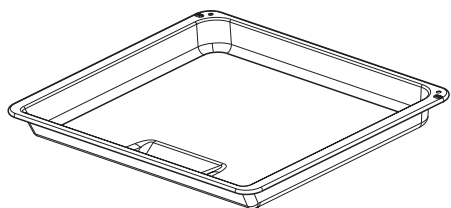

*Roasting tray\**

*Sideracks*

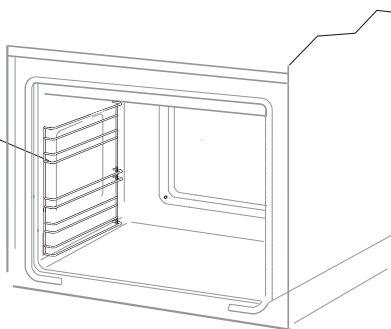

\*optional

# INSTALLATION

## Installing the oven

- The kitchen area should be dry and aired and equipped with efficient ventilation. When installing the oven, easy access to all control elements should be ensured.
- This is a Y-type design built-in oven, which means that its back wall and one side wall can be placed next to a high piece of furniture or a wall. Coating or veneer used on fitted furniture must be applied with a heat-resistant adhesive (100°C). This prevents surface deformation or detachment of the coating.
- Hoods should be installed according to the manufacturer's instructions.
- Make an opening with the dimensions given in the diagram for the oven to be fitted.
- Make sure the mains plug is disconnected and then connect the oven to the mains supply.
- Insert the oven completely into the opening without allowing the four screws in the places shown in the diagram to fall out.

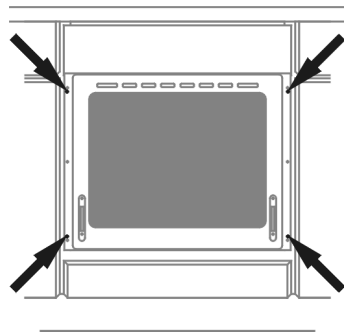
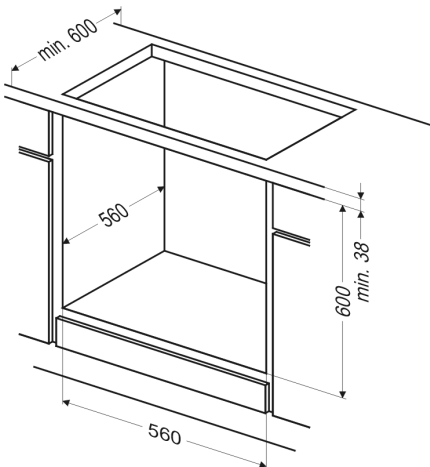
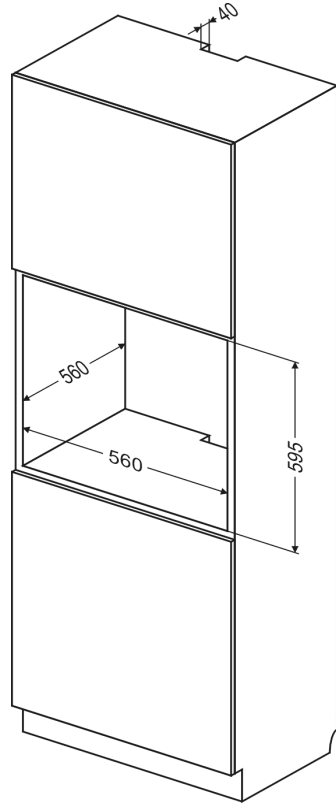

# INSTALLATION

## Electrical connection

**Warning:** This appliance must be earthed.

The appliance must be installed by a competent electrician using a double pole control unit of 16 ampere minimum capacity with 3 mm minimum contact separation at all poles.

We recommend that the appliance is connected by a qualified electrician who is member of the N.C.E.I.C. and who will comply with the I.E.E. and local regulation.

- Access to the main terminal is gained by opening the terminal block cover at the rear of the appliance (use a small flat-bladed screwdriver).
- Connection should be made with 4 mm<sup>2</sup> twin and earth cable.
- First strip the wires, then push the cable through the cable clamp in the terminal block cover.
- Connect the cable to the terminal block and tighten the cable clamp screw (see diagram).
- Ensure the cable exits through the cable grip clamping on the outer sheath of the cable and fix in place by tightening the fixing screw.
- Ensure all screws are adequately tightened. Do not over tighten as you may risk damaging the screw threads.
- Close the terminal box, ensuring that the cover is engaged on the locking tabs.
- The supply cable must be positioned away from any hot parts of the rear of the appliance. If this cannot be done then another method of protecting the supply cable from the hot parts must be used i.e. Heat resistant sleeving or high temperature cables.

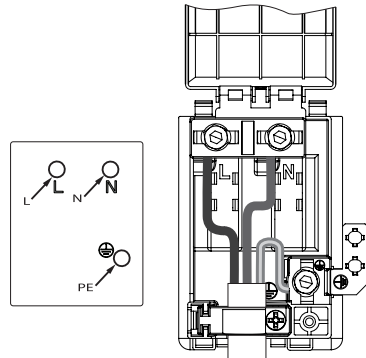

**220-240V 1N~**

L - Live (Red or Brown)  
N - Neutral (Black or Blue)  
PE - Earth (Green/Yellow or sleeving)

Grounding lead must be connected to screw with  symbol.

The power supply cable must have these minimum requirements:

- Type: HO5VV-F (PVC insulated and sheathed flexible cable)
- 3 cores x 4 mm<sup>2</sup> .

# OPERATION

## Before using the appliance for the first time

- Remove packaging, clean the interior of the oven.
- Take out and wash the oven fittings with warm water and a little washing-up liquid.
- Switch on the ventilation in the room or open a window.
- Heat the oven (to a temperature of 250°C, for approx. 30 min.), remove any stains and wash carefully.

The oven is equipped with a retractable knobs. In order to select a function do the following:

1. Gently press and release a knob which will pop out,
2. Turn the oven functions selection knob to the desired function.

Symbols printed around the knob indicate available oven functions.

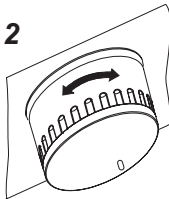
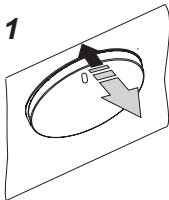

## Important!

In ovens equipped with the electronic programmer Ts, the time “0.00” will start flashing in the display field upon connection to the power supply.

**The programmer should be set with the current time. (See *Electronic programmer* ). If the current time is not set operation of the oven is impossible.**

The electronic programmer Ts is equipped with electronic sensors which are switched on by touching or pressing the sensor surface for at least one second.



Each sensor reaction is confirmed by the beep. Keep the sensor surface clean at all times.

## Important!

The inside of the oven should only be washed with warm water and a small amount of washing-up liquid.

# OPERATION

## Electronic programmer

   functions

**MENU** – function selection button

< - sensor “-”

> - sensor “+”

The electronic programmer is equipped with electronic sensors which are switched on by touching or pressing the sensor surface for at least one second.

Each sensor reaction is confirmed by the beep. Keep the sensor surface clean at all times.

### Setting the time

After connection to the mains or reconnection after a power cut the display shows flash 



● Press sensor **MENU**, then the display will show ,

● set the time using sensors < and >.

7 seconds after the time has been set the new data will be saved.

### Caution!

If the correct time is not set then proper operation of the oven is not possible.

## Timer

The timer can be activated at any time, regardless of the status of other functions. The timer can be set for from 1 minute to up to 23 hours and 59 minutes.

To set the timer you should:

● Press sensor **MENU**, then the display will show flashing ,

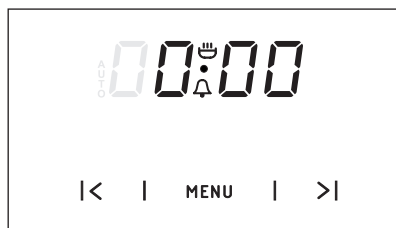

● set the timer using sensors > and <.

The time set is shown on the display and the signal function  is on.

● Press sensor **MENU**, < or > in order to switch off the signal, the signal function will go out and the display will show the current time.

### Caution!

If the alarm signal is not turned off manually, it will be turned off automatically after approx. 7 minutes.

# OPERATION

## Semi-automatic operation

If the oven is to be switched off at a given time, then you should:

- Set the oven function knob and the temperature regulator knob to the setting at which you want the oven to operate.

- Press sensor **MENU** until the display will show:



- Set the required time using sensors < and >, within a range from 1 minute to 10 hours.

The set time will be introduced to the memory after approx. 7 seconds and the display will show AUTO function.

When the set time has passed the oven is switched off automatically, the alarm signal is activated and the signal function AUTO flashing again;

- Set the oven function knob and the temperature regulator knob to the switched-off position.

- Press sensor **MENU**, < and > in order to switch off the signal; the signal function will go out and the display will show the current time.

### Caution!

In ovens equipped with one control knob, the oven function knob is integrated with the temperature regulator knob.

## Automatic operation

If the oven is to be switched on for a specified period of time and switched off at a fixed hour then you should set the operation time and the operation end time:

- Press sensor **MENU** until the display will show:



- Set the required time using the sensors < and > within a range from 1 minute to 10 hours.

- Press sensor **MENU** until the display will show:



- Set the switch-off time (operation end time) using sensors < and >, which is limited to a period of 23 hours and 59 minutes from the current time.

- Set the oven function knob and the temperature regulator knob to the setting at which you want the oven to operate.

## OPERATION

The function AUTO is now on; the oven will start operating from the point when the difference between the set operation end time and the operation duration time occurs (e.g. the operation time is set to 1 hour, the operation end time is set to 14.00, so the oven will start working automatically at 13.00).

When the oven reaches the operation end time it will switch off automatically, the alarm will be activated and the function AUTO will start flashing again.

- Set the oven function knob and the temperature regulator knob to the switched-off position.
- Press sensor **MENU**, < and > in order to switch off the alarm; the function AUTO will go out and the display will show the current time.

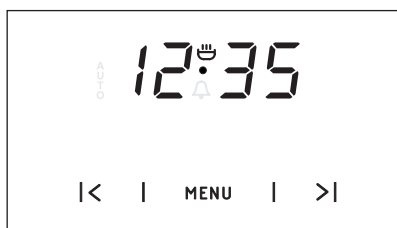

### Cancel settings

Timer and automatic function settings may be cancelled at any time.

Cancel automatic function settings:

- press sensors < and > simultaneously,

Cancel timer settings:

- press sensor **MENU** to select timer settings,
- press sensors < and > again,

### Change the timer beeps

The tone of the timer beeps may be changed as follows:

- press sensors < and > simultaneously,
- select "tone" function with the **MENU** sensor, the display panel will start to blink:

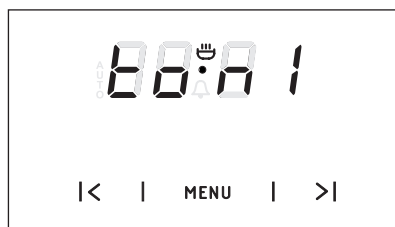

- with the > sensor press the appropriate sensors from 1 to 3 to select the option you wish.

# OPERATION

## Oven functions and operation.

### Oven with automatic air circulation (including a fan and an ultra-fan heater)

The oven can be heated up using the bottom and top heaters, the grill or the ultra-fan heater. Operation of the oven is controlled by the oven function knob – to set a required function you should turn the knob to the selected position, and the temperature regulator knob – to set a required function you should turn the knob to the selected position.

The oven is equipped with a retractable knobs. In order to select a function do the following:

- gently press and release a knob which will pop out,
- turn the oven functions selection knob to the desired function.

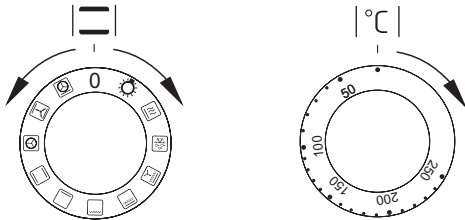

The oven can be switched off by setting both of these knobs to the position "●"/"0".

### Caution!

When selecting any heating function (switching a heater on etc.) the oven will only be switched on after the temperature has been set by the temperature regulator knob.

**0** Oven is off



### Independent oven lighting

Set the knob in this position to light up the oven interior.



### Rapid Preheating

Top heater, roaster and fan on. Use to preheat the oven.



### Defrosting

Only fan is on and all heaters are off.



### Fan and combined grill on

When the knob is turned to this position, the oven activates the combined grill and fan function. In practice, this function allows the grilling process to be speeded up and an improvement in the taste of the dish. You should only use the grill with the oven door shut.



### Enhanced roaster (super roaster)

In this setting both roaster and top heater are on. This increases temperature in the top part of the oven's interior, which makes it suitable for browning and roasting of larger portions of food.



### Roaster on.

Roasting is used for cooking of small portions of meat: steaks, schnitzel, fish, toasts, Frankfurter sausages, (thickness of roasted dish should not exceed 2-3 cm and should be turned over during roasting).



## OPERATION

---



### **Bottom heater on**

When the knob is set to this position the oven is heated using only the bottom heater. Baking of cakes from the bottom until done (moist cakes with fruit stuffing).



### **Top and bottom heaters on**

Set the knob in this position for conventional baking. This setting is ideal for baking cakes, meat, fish, bread and pizza (it is necessary to preheat the oven and use a baking tray) on one oven level.



### **Convection with ring heating element**

Setting the knob in this position allows the oven to be heated up by a heating element with air circulation forced by a rotating fan fitted in the central part of the back wall of the oven chamber. Lower baking temperatures than in the conventional oven can be used. Heating the oven up in this manner ensures uniform heat circulation around the dish being cooked in the oven.



### **Top heater, bottom heater and fan are on.**

This knob setting is most suitable for baking cakes. Convection baking (recommended for baking).

When the  functions have been selected but the temperature knob is set to zero only the fan will be on. With this function you can cool the dish or the oven chamber.



### **Convection with ring heating element and bottom heater on**

With this setting the convection fan and bottom heater are on, which increases the temperature at the bottom of the cooked dish. Intense heat from the bottom, moist cakes, pizza.

Switching on the oven is indicated by red signal light, turning on. If the red light goes out, it means the oven has reached the set temperature. If a recipe recommends placing dishes in a warmed-up oven, this should be not done before the red light goes out for the first time. When baking, the red light will temporarily come on and go out (to maintain the temperature inside the oven).

# OPERATION

---

## Use of the grill

---

The grilling process operates through infrared rays emitted onto the dish by the incandescent grill heater.

In order to switch on the grill you need to:

- Set the oven knob to the position marked grill.
- Heat the oven for approx. 5 minutes (with the oven door shut).
- Insert a tray with a dish onto the appropriate cooking level; and if you are grilling on the grate insert a tray for dripping on the level immediately below (under the grate).
- Close the oven door.

**For grilling with the function grill and combined grill the temperature must be set to 250°C, but for the function fan and grill it must be set to a maximum of 200°C.**

## Warning!

When using function grill it is recommended that the oven door is closed.

When the grill is in use accessible parts can become hot.

It is best to keep children away from the oven.

## BAKING IN THE OVEN – PRACTICAL HINTS

---

### Baking

































- we recommend using the baking trays which were provided with your cooker;
- it is also possible to bake in cake tins and trays bought elsewhere which should be put on the drying rack; for baking it is better to use black trays which conduct heat better and shorten the baking time;
- shapes and trays with bright or shiny surfaces are not recommended when using the conventional heating method (top and bottom heaters), use of such tins can result in undercooking the base of cakes;
- when using the ultra-fan function it is not necessary to initially heat up the oven chamber, for other types of heating you should warm up the oven chamber before the cake is inserted;
- before the cake is taken out of the oven, check if it is ready using a wooden stick (if the cake is ready the stick should come out dry and clean after being inserted into the cake);
- after switching off the oven it is advisable to leave the cake inside for about 5 min.;
- temperatures for baking with the ultra-fan function are usually around 20 – 30 degrees lower than in normal baking (using top and bottom heaters);
- the baking parameters given in Table are approximate and can be corrected based on your own experience and cooking preferences;
- if information given in recipe books is significantly different from the values included in this instruction manual, please apply the instructions from the manual.

### Roasting meat

- cook meat weighing over 1 kg in the oven, but smaller pieces should be cooked on the gas burners.
- use heatproof ovenware for roasting, with handles that are also resistant to high temperatures;
- when roasting on the drying rack or the grate we recommend that you place a baking tray with a small amount of water on the lowest level of the oven;
- it is advisable to turn the meat over at least once during the roasting time and during roasting you should also baste the meat with its juices or with hot salty water – do not pour cold water over the meat.

## BAKING IN THE OVEN – PRACTICAL HINTS

Oven with automatic air circulation (including a fan and an ultra-fan heater)

Type of dish	Oven functions	Temperature	Level	Time in minutes
		160 - 200	2 - 3	30 - 50
		160 - 180	2	20 - 40*
		140 - 160	2	10 - 40*
		200 - 230	1 - 3	10 - 20
		210 - 220	2	45 - 60
		160 - 180	2 - 3	45 - 60
		190	2 - 3	60 - 70
		230 - 250	4	14 - 18
		225 - 250	2	120 - 150
		160 - 180	2	120 - 160
		160 - 230	2	90 - 120
		160 - 190	2	90 - 120
		190	2 - 3	50 - 60
		160 - 180	2	45 - 60
		175 - 190	2	60 - 70
		190 - 210	2	40 - 50
		170 - 190	3	40 - 50

\* Baking smaller items

### Caution!

The figures given in Tables are approximate and can be adapted based on your own experience and cooking preferences.

## CLEANING AND MAINTENANCE

By ensuring proper cleaning and maintenance of your cooker you can have a significant influence on the continuing fault-free operation of your appliance.

**Before you start cleaning, the cooker must be switched off and you should ensure that all knobs are set to the “Off” position. Do not start cleaning until the cooker has completely cooled.**

- The oven should be cleaned after every use. When cleaning the oven the lighting should be switched on to enable you to see the surfaces better.
- The oven chamber should only be washed with warm water and a small amount of washing-up liquid.
- **Steam Clean function**
  - Pour approximately 0.25 ml (1 glass) of water onto the tray inserted on level one in the oven.
  - Close the oven door,
  - set the temperature adjustment knob to 50°C, and the function selector knob to bottom heater position 
  - heat the oven chamber for about 30 minutes,
  - When the steam cleaning process is completed, wipe out the chamber with a damp cloth or a sponge soaked in a mild solution of washing-up liquid.
- After cleaning wipe over chamber dry.
- Use a soft, moisture absorbing cloth to clean surfaces

### Caution!

Do not use cleaning products containing abrasive materials for the cleaning and maintenance of the glass front panel.

### Replacement of the oven light bulb

**In order to avoid the possibility of an electric shock ensure that the appliance is switched off before replacing the bulb.**

- Set all control knobs to the position “●”/“0” and disconnect the mains plug,
- unscrew and wash the lamp cover and then wipe it dry.
- unscrew the light bulb from the socket, replace the bulb with a new one – a high temperature bulb (300°C) with the following parameters:
  - voltage 230 V
  - power 25 W
  - thread E14.

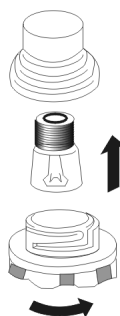

Oven light bulb

- Screw the bulb in, making sure it is properly inserted into the ceramic socket.
- Screw in the lamp cover.

## CLEANING AND MAINTENANCE

---

### Dismounting the side racks

Ovens marked with the letter **D** are equipped with easily removable wire guides (side racks) of oven inserts. To remove them for washing purposes, pull the front catch (Z1), then tilt the guide and remove it from the rear catch (Z2). After washing the guides, put them in the mounting holes of the oven and press the catches (Z1 and Z2).

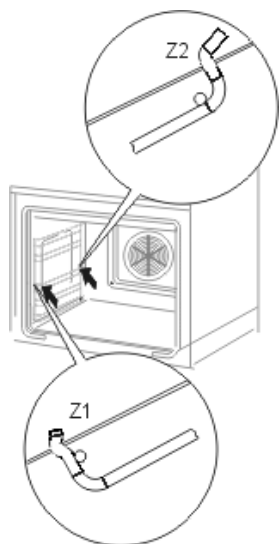

*Dismounting the side racks*

Ovens types marked with the letters **Db** in the model number have moveable stainless telescopic runners attached to the side racks. The runners should be taken out and washed along with the side racks. Before putting trays on the telescopic runners they should be pulled out (if the oven is warmed up the runners should be pulled out by hooking the back edge of trays on the bumpers in the front part of the telescopic runners) and then insert them together with a tray.

# CLEANING AND MAINTENANCE

## Door removal

In order to obtain easier access to the oven chamber for cleaning, it is possible to remove the door. To do this, tilt the safety catch part of the hinge upwards (fig. A). Close the door lightly, lift and pull it out towards you. In order to fit the door back on to the cooker, do the inverse. When fitting, ensure that the notch of the hinge is correctly placed on the protrusion of the hinge holder. After the door is fitted to the oven, the safety catch should be carefully lowered down again. If the safety catch is not set it may cause damage to the hinge when closing the door.

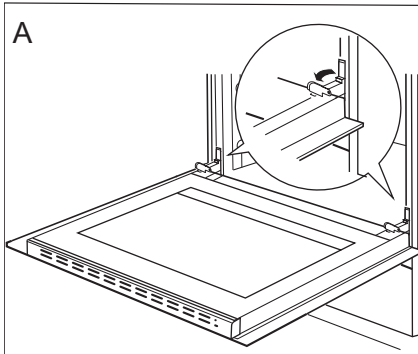

*Tilting the hinge safety catches*

## Removing the inner panel

1. Using a flat screwdriver unhook the upper door slat, prying it gently on the sides (fig. B).
2. Pull the upper door slat loose. (fig. B, C)

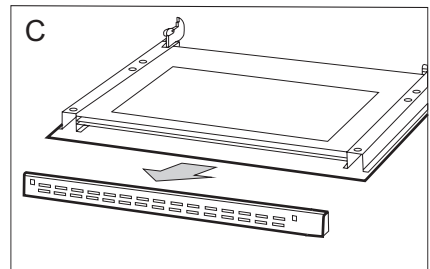
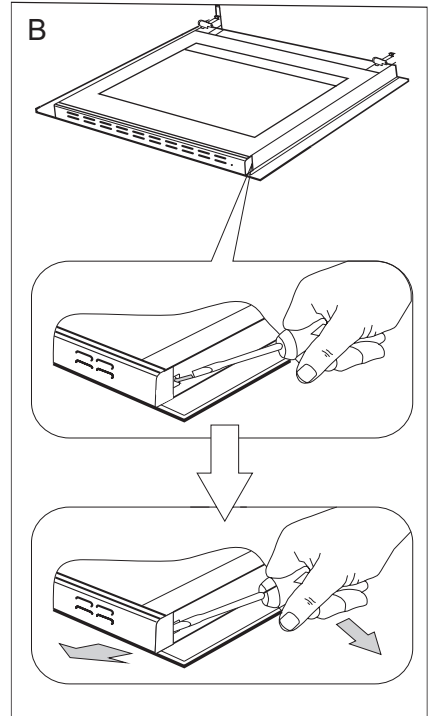

## CLEANING AND MAINTENANCE

3. Pull the inner glass panel from its seat (in the lower section of the door). Remove the inner panel (fig. D).
4. Clean the panel with warm water with some cleaning agent added.

Carry out the same in reverse order to reassemble the inner glass panel. Its smooth surface shall be pointed upwards.

**Important! Do not force the upper strip in on both sides of the door at the same time.** In order to correctly fit the top door strip, first put the left end of the strip on the door and then press the right end in until you hear a “click”. Then press the left end in until you hear a “click”.

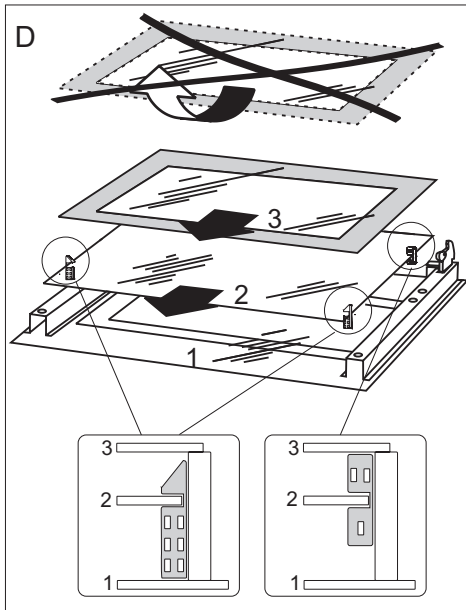

*Removal of the internal glass panel*

### Regular inspections

Besides keeping the oven clean, you should:

- carry out periodic inspections of the control elements and cooking units of the cooker. After the guarantee has expired you should have a technical inspection of the cooker carried out at a service centre at least once every two years,
- fix any operational faults,
- carry out periodical maintenance of the cooking units of the oven.

### Caution!

All repairs and regulatory activities should be carried out by the appropriate service centre or by an appropriately authorised fitter.



## CLEANING AND MAINTENANCE

---

### ▶ Regular inspections

Besides keeping the oven clean, you should:

- carry out periodic inspections of the control elements and cooking units of the cooker. After the guarantee has expired you should have a technical inspection of the cooker carried out at a service centre at least once every two years,
- fix any operational faults,
- carry out periodical maintenance of the cooking units of the oven.

### Caution!

All repairs and regulatory activities should be carried out by the appropriate service centre or by an appropriately authorised fitter.

## OPERATION IN CASE OF EMERGENCY

---

In the event of an emergency, you should:

- switch off all working units of the oven
- disconnect the mains plug
- call the service centre
- some minor faults can be fixed by referring to the instructions given in the table below. Before calling the customer support centre or the service centre check the following points that are presented in the table.

PROBLEM	REASON	ACTION
1. The appliance does not work.	Break in power supply.	Check the household fuse box; if there is a blown fuse replace it with a new one.
2. The programmer display shows "0:00".	The appliance was disconnected from the mains or there was a temporary power cut.	Set the current time (see ' <i>Use of the programmer</i> ').
3. The oven lighting does not work.	The bulb is loose or damaged.	Tighten up or replace the blown bulb (see ' <i>Cleaning and Maintenance</i> ').

## TECHNICAL DATA

---

Rated Voltage	220-240V ~50Hz
Power	3,1 kW
Oven:	
bottom heater	1,1 kW
top heater	0,9 kW
grill	2,0 kW
ultra-fan	2,0 kW
Cooker dimensions H/W/D	59,5 / 59,5 / 57,5 cm
Complies with EU regulations	EN 60335-1, EN 60335-2-6 standards

### *Certificate of compliance CE*

*The Manufacturer hereby declares that this product complies with the general requirements pursuant to the following European Directives:*

- *The Low Voltage Directive 2006/95/EC,*
- *Electromagnetic Compatibility Directive 2004/108/EC,*
- *ErP Directive 2009/125/EC,*

*and therefore the product has been marked with the **CE** symbol and the **Declaration of Conformity** has been issued to the manufacturer and is available to the competent authorities regulating the market.*



# Amica

 Service Help Line

For the UK: please call **0844 815 8880**

For Ireland: please call **0818 46 46 46**

---