

Amica



PHCZ6511 / PHCG4.1ZpZtC

INSTRUCTION MANUAL

Sticker with serial number of appliance

DEAR CUSTOMER,

Thank you for your purchase of an Amica gas hob; we hope you enjoy many years of use from our product.

We would ask that you take the time to read through this handbook, even if you have used a gas hob in the past, so that you are familiar with its operation, features and maintenance to ensure the best and most efficient possible use of your hob.

Please keep this user manual and store it near the appliance, so that it is available at all times for reference. We would also advise that you take a note of the exact model number of your hob either from the packaging label or from the rating plate for future reference.

Please observe the safety instructions contained within this manual to prevent accidents.



Note

Do not start to use the appliance before you have read and understood the instructions.

This equipment has been designed solely as a cooking appliance. It is strictly prohibited to use it for any other purpose, e.g. heating. Using the appliance for other purposes can be dangerous.



The manufacturer reserves the right to introduce modifications which will not affect the functionalities and operation of the appliance.

TABLE OF CONTENTS

GENERAL SAFETY	4
WHAT TO DO IF YOU SMELL GAS	6
UNPACKING	7
SAFE DISPOSAL	7
OVERVIEW OF THE HOB	8
INSTALLATION	9
OPERATION	15
CLEANING AND ROUTINE MAINTENANCE	19
TROUBLESHOOTING	20

PRODUCT INFORMATION

Product information given in accordance with Commission Regulation (EU) No 66/2014 supplementing Directive of the European Parliament and Council Directive 2009/125/EC with regard to eco-design requirements for household ovens, hobs and range hoods

Household gas hobs

Model identifier		PHCZ6511
		PHCG4.1ZpZtC
		1106084
Hob type (electric / gas / gas-electric)		O / V / O
Number of gas burners		4
Energy efficiency for each gas burner (EE gas burner)	FL	53,5
	RL	53,5
	RR	53,5
	FR	53,5
	C	-
Energy efficiency of gas hob (EE gas hob)		53,5

In order to determine compliance with the eco-design requirements, the measurement methods and calculations of the following standards were applied:

EN 60350-1
EN 60350-2
EN 15181
EN 30-2-1

GENERAL SAFETY

Your safety and that of your family are of the utmost importance to us and although some simple safety when cooking is generally observed it is worth reading through the following points to ensure that your hob is operated as safely as possible at all times to prevent any accidents.

As a responsible company we feel it is very important to maintain a very high level of safety and to make this section as clear and highlighted as possible.

Should you have any additional concerns or questions on any safety related matters please feel free to contact our service department on 0844 815 8880 (UK) or 0818 464646 (ROI) and our staff will endeavour to help you with any questions you may have.

- Do not leave children unattended in an area where the appliance is in use.
- Do not allow persons of limited physical, sensual, or psychological capabilities, or persons whose experience in operating similar appliances is limited to operate the cooktop, unless if attended by (adult) caretakers.
- Make sure no part of the power cord comes in contact with hot parts of the hob.
- Leave sufficient space around the socket to ensure the power plug is accessible easily after installation.
- Do not install the hob near cooling appliances.
- Do not leave the hob unattended while in use. Boil-overs cause smoking, and greasy spill-overs may ignite presenting a fire risk.
- Execute caution when the food is boiling. Boil-overs may flood the burner.
- Should a malfunction occur, stop using the appliance. Do not start to use your hob before a Gas Safe engineer has repaired it.
- Make sure all the burners are closed before opening the main gas valve at the network or container connection.
- Do not place cooking pans directly onto the burners.
- Maximum weight of a pan to be placed over a single burner

GENERAL SAFETY

is 5 kg. The overall maximum load of a pan that is to be placed over the entire grate is 10 kg. Do not place a single pan over two burners at the same time.

- Do not impact the burners and knobs.
- It is prohibited to modify or repair the hob by persons who do not possess appropriate training and qualifications.
- Do not set the burner knobs open before you have stricken the match or the ignition appliance.
- Do not extinguish the flame by blowing.
- The user is not allowed to convert the hob to another gas type, relocate the appliance, or modify the supply network himself. Only a duly authorised and Gas Safe is allowed to carry out these activities.
- Do not connect antenna cords (e.g. radio antennae) to the gas pipes.

WHAT TO DO IF YOU SMELL GAS

If you smell gas then please follow the points below for your immediate safety.

All our gas appliances are checked for gas soundness before they leave our factory and it is extremely rare that one of our products will leak gas. Before calling our service department please ensure that there is a fault with the product as any faults with other gas appliances that you may have or improper installation are not covered by our warranty and any visit may be chargeable to you.

Our service department can be on 0844 815 8880 (UK) or 0818 464646 (ROI) and our staff will endeavour to help you with any questions you may have.

1. Do not ignite any naked flame or spark
2. Do not switch any electrical sockets or appliances on or off
3. Open all windows and doors to the room
4. Turn off the supply to the hob (there should be an isolation tap in an adjacent cupboard fitted)
5. If possible and safe, remove power from the hob or pull out the plug
6. If you still smell gas after doing this and allowing the air to clear, switch off the main supply

If you still smell or hear gas after the hob is isolated and the supply is switched off then call National Grid on 0800 111 999 (UK) or 1850 20 50 50 (ROI) for further advice 24 hours a day

If you have isolated the problem to the hob please call our service department for further assistance on 0844 815 8880 (UK) or 0818 464646 (ROI).



Never have your gas hob installed or serviced by anyone who is not Gas Safe registered and qualified to work on the product



- If the gas leaking from the piping network has ignited, close the gas supply immediately by closing the mains / supply valve.
- If the gas leaking from a container has ignited, cover the contained with a wet blanket, and close the container valve immediately. After the container has cooled down, take it outdoor. It is strictly prohibited to use the failed container again.
- Close the mains / supply valve if a break of a couple of days in the usage of the appliance is expected. Close the valve each time after the use of the appliance if your cooktop is connected to a gas container.
- Caution! Should the permanently sealed supply cord break, have it replaced by the manufacturer or by a Gas Safe registered repair service.

Please Note:

When Gas Safe is mentioned in this instruction booklet, this also refers to the Register of Gas Installers Ireland (RGII).

UNPACKING

During transportation, protective packaging was used to protect the appliance against any damage. After unpacking, please dispose of all elements of packaging in a way that will not cause damage to the environment.

All materials used for packaging the appliance are environmentally friendly; they are 100% recyclable and are marked with the appropriate symbol.

Caution! During unpacking, the packaging materials (polythene bags, polystyrene pieces, etc.) should be kept out of reach of children.

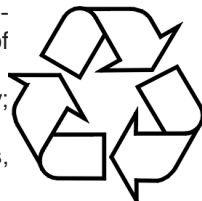

SAFE DISPOSAL

Old appliances should not simply be disposed of with normal household waste, but should be delivered to a collection and recycling centre for electric and electronic equipment. A symbol shown on the product, the instruction manual or the packaging shows that it is suitable for recycling.

Materials used inside the appliance are recyclable and are labelled with information concerning this. By recycling materials or other parts from used devices you are making a significant contribution to the protection of our environment.

Information on appropriate disposal centres for used devices can be provided by your local authority.



OVERVIEW OF HOB

PHCZ6511 / PHCG4.1ZpZtC

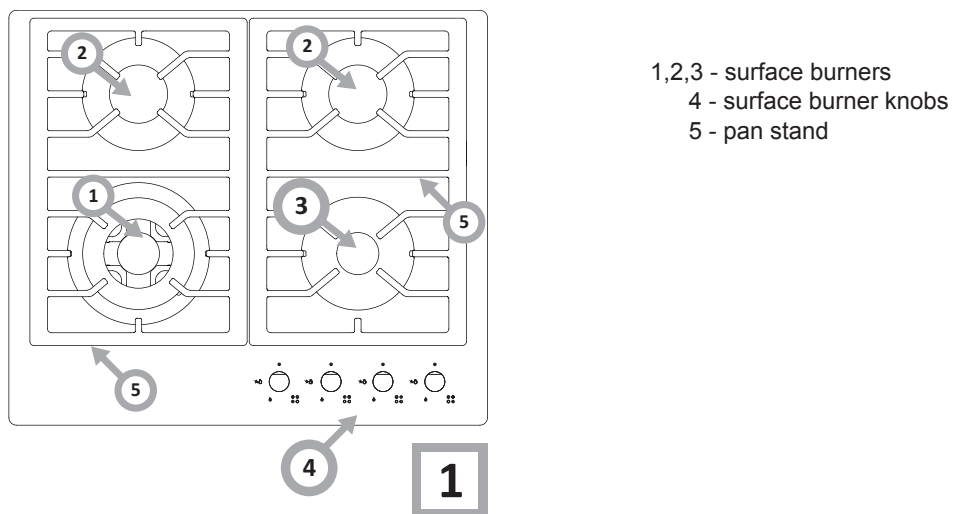

Fig.2

TECHNICAL DATA

- height	98 mm
- depth	520 mm
- width	600 mm
- weight of the hob	13,5 kg

The cooker is equipped with burners:

1 - WOK burner, output	- 2,8 kW
2 - small burner, output	- 1 kW
3 - medium burners, output	- 1,8 kW

Appliance class: II_{2H3+}

The cooker is equipped with a pipe terminal - 1/2" ISO 228-1

INSTALLATION

Installation work and repairs should only be performed by a Gas Safe qualified technician in accordance with all applicable codes and standards. Repairs and service by unqualified persons could be dangerous or incorrect and are not covered by your warranty. Correct installation is absolutely vital for safe operation of this appliance.

We do not recommend that a gas appliance be installed on a DIY basis.

Once installed correctly your Gas Safe installer should certify the appliance as safe for use.

Location

- The kitchen must be dry and well ventilated.
- The kitchen should have a ventilation system including fume exhaust to remove the gases generated by burning gas and direct them out. That system shall comprise a ventilation grill or a hood. Please install hoods in accordance with the manufacturers' instructions.
- Fresh air is necessary to ensure gas burning. Minimum gas requirement for the cooktop is 2 cbm per hour per each 1 kW of the burners' capacity. The air can be supplied either directly from the outside by an at least 100 cm² duct, or directly from the adjacent rooms, provided these are equipped with ventilation system routed to the outside of the building.
- The minimum distance between the burners and the hood exhaust should be 750 mm (see fig. 3).

Fig. 3

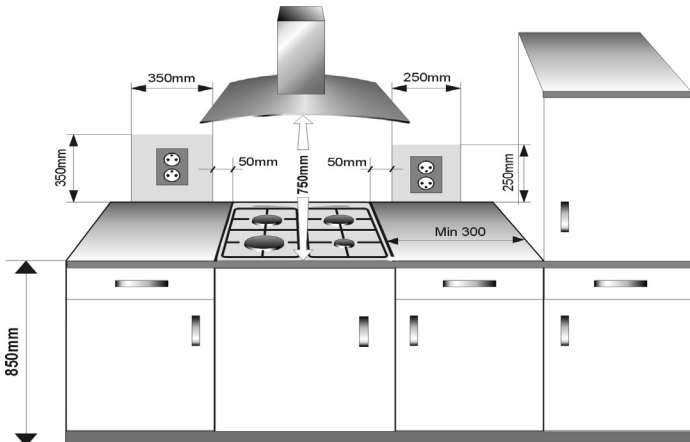

INSTALLATION

Installation of the cooktop:

- Prepare the work top cut-out as shown in the diagram (see fig. 5).
- Remember to maintain the minimum safety distances to combustible surfaces below the cooktop of 130 mm.
- Fix the tape (included) to the cooktop edge at the bottom side of the appliance.
- Connect the appliance to gas and electrical mains as per the operating manual.
- Remove any dust from the work top, remove the protective backing of the tape, insert the cooktop into the cut-out, and press firmly downwards.
- Set the fixing brackets (see fig. 4) perpendicular to the cooktop edge, fix firmly.
- Test the correct operation of the installed cooktop. In particular, check the correct operation of the sealing protection and the ignition system.

Fixing the brackets to the work top

Fig. 4

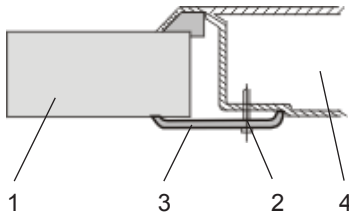

1. Work top
2. 4 screws
3. 4 fixing brackets
4. Installed appliance

Installation in kitchen furniture

Fig. 5

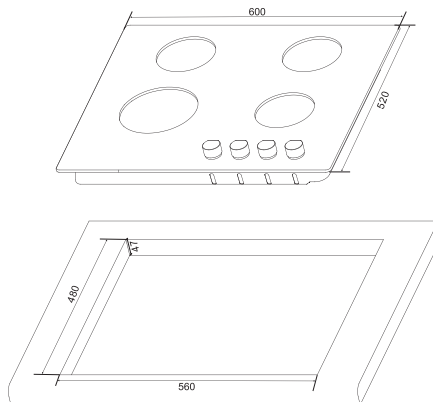

INSTALLATION

Notes for the installer:

The fitter should:

- Bear a valid certificate of Gas Safe Registration
- Have studied the contents of the appliance's type plate containing the suitable type of gas. Compare the data with the characteristics of the gas available in the supply.
- Check the following:
 - ventilation capacity, incl. air exchange in the kitchen,
 - tightness and sealing of the gas fittings,
 - effectiveness and correct operation of all the functional elements.
- Adjust the settings of the gas control knobs with the washers included to ensure the igniters work properly and the entire system is leak-proof;
 - check the operation of the igniters and leak seal,
 - remove the knob if working incorrectly, and adjust by introducing washer(s) onto the valve spindle,
 - check the operation of the igniters and leak seal,
 - secure the system with a tight washer and put the knob handle on.
- Issue a certificate of connecting the appliance and inform the user of the operation.

Installation and service must be performed by a qualified and Gas Safe Registered installer, service agency or gas supplier. All the relevant safety regulations must be observed.



The cooktop is equipped with an R1/2" connecting pipe for gas connection. If the appliance is intended for use with LPG (propane – butane), a Ø 8 x 1 mm hose coupling is threaded onto the connector.

Make sure the gas connecting pipe does not come in contact with the metal components of the cooktop.

**All the couplings and joints must be tightly sealed.
Do not check the fittings with open flame!
Appliance must be installed by a Gas Safe installer
After connecting the appliance check all fittings for gas soundness**

INSTALLATION



Please make sure you have read and understood the entire operating manual. Do follow the instructions to ensure safe and effective operation of your cooktop.

NOTE

The appliance uses gas, which is a flammable and explosive substance. Thus, it is necessary for the cooktop to be connected to a gas network which supplies the gas type for which the appliance is suitable.

Installation and service must be performed by a qualified installer, service agency or gas supplier.

Please check the type plate for the information concerning the suitable gas type for your appliance.

▶ Converting the unit to another gas type

Only a licensed and authorised technician may carry out this job.

If the available gas type is different from that provided in the type plate of the appliance 2H (G20/20 mbar), the burner nozzles should be replaced and flame adjusted.



NOTE

The cooktops delivered by the supplier come with the burners which are suitable for burning the type of gas which is quoted in the type plate and in the guarantee certificate. The type plate is fitted at the bottom panel of the appliance. The following must be carried out if converting to another gas type is required:

- nozzles must be replaced (see assembling table),
- reduced valve flow rate must be adjusted.

▶ Converting the unit to another gas type

Table 1

Gas type	Nozzle diameter			
	Small	Medium	Large	WOK
2H G20/20mbar	72	92	-	55 + 2 x 75
3+ G30/31 28+30/37mbar	52	67	-	37 +2 x 55

INSTALLATION

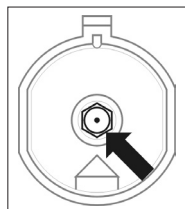

Replacement of burner nozzle: loosen the nozzle with a dedicated wrench (7). Fit the new nozzle, suitable for the required gas type (see table above for reference).



After you have converted the cooktop to another gas type, make sure you have placed a label containing that information on the appliance.

▶ Adjustment of the reduced valve flow

Table 2

Burners	Flame	Converting the cooktop from LPG to natural gas	Converting the cooktop from natural gas to LPG
Regular burners	Full flame	Replace the burner nozzle according to the guidelines in table 1	Replace the burner nozzle according to the guidelines in table 1
	Saving flame	Loosen the adjustment spindle (see fig. 7) and adjust the flame	Loosen the adjustment spindle (see fig. 7) and adjust the flame

INSTALLATION

▶ Valve adjustment

Valve adjustment should be done with the control knob set at Burner ON saving flame position.

Remove the knob, and adjust the flame with a tiny screwdriver (see fig. 7 below).

Fig. 7



Checking the adjusted flame: heat the burner at full open position for 10 minutes. Then turn the knob into the saving setting. The flame should not extinguish nor move to the nozzle. If it goes off or moves over to the nozzle, readjust the valves.



These adjustments must be performed by a qualified and Gas Safe Registered installer, service agency or gas supplier. All the relevant safety regulations must be observed.



Failure to observe this policy may affect your warranty



OPERATION

▶ Flame selection

If the burners are adjusted correctly, the flames should be light blue, and the inner cone should be clearly visible. The size of flame depends on the position of the related burner control knob.

Fig. 8

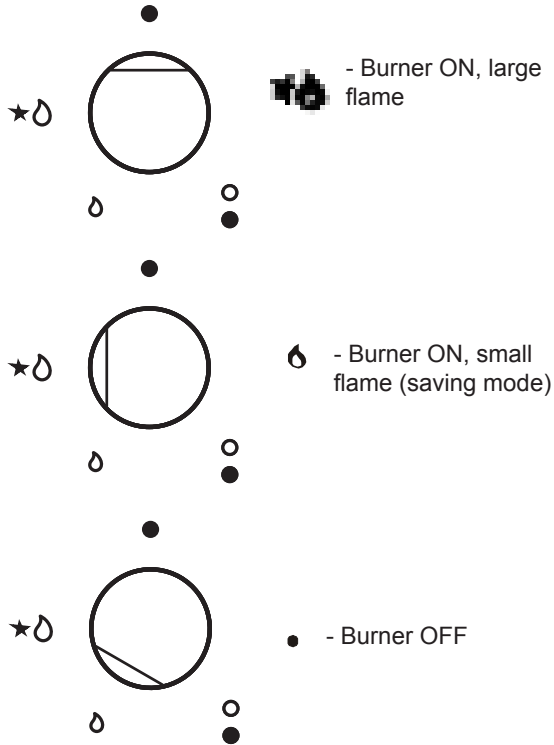

See also fig. 8 for various operating options (flame size selection); the burner should be set at a large flame during the initial phase of cooking to bring the food to boiling, and then the knob should be turned to the saving flame position to maintain the cooking. It is also possible to adjust the flame size stepless.



It is prohibited to adjust the flame in the range between the Burner OFF and Burner ON large flame positions.

OPERATION

You can save significant quantities of energy if the appliance is used correctly, parameters set correctly, and appropriate cookware is used. The savings can be as follows:

- Up to 60 per cent savings when proper pots are used,
- Up to 60 per cent savings when the unit is operated correctly and the suitable flame size is chosen.

It is a prerequisite for efficient and energy-saving operation of the cooktop that the burners are kept clean at all times (in particular the flame slots and nozzles).

► Suitable pans

Most types of pan are suitable for use on a gas hob but please check the base where on most modern pans logos will be used to indicate suitability for use on the various types of cooking surface.

Bear in mind that the diameter of the pot must be at least slightly larger than that of the flame.

It is recommended to use pots the diameters of which exceed the diameters of the flame by 2.5 – 3 times;

- For the small burner, the most suitable pot will be 90-140 mm in diameter,
- For the medium burner, the most suitable pot will be 140-220 mm in diameter,
- For the large burner, the most suitable pot will be 200-240 mm in diameter,
- For the WOK burner, the most suitable pot will be 220-260 mm in diameter,
- The height of the pot should not be larger than its diameter.

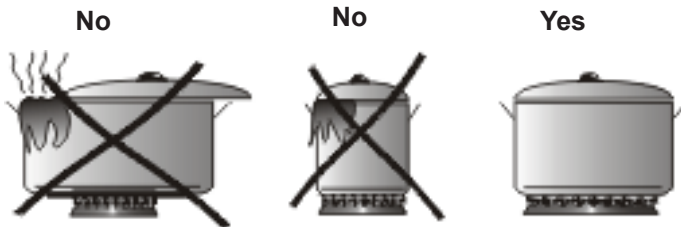

Please do pay attention to the pan size in relation to the flame diameter in accordance with the instructions above.

If you have the flame too high then the heat will be forced up the outside of the pan not only wasting energy and costing you more to cook the food but it can also make the handles of the pan very hot.

The use of a lid will not only reduce the cooking time but it will also save a considerable amount of energy and the use of a lid when cooking is highly recommended.

Following these simple tips will save you both time and money.

OPERATION

Using cooktops with control knob ignition (Zp)



- Press the selected control knob and turn anti-clockwise into Burner ON large flame position.
- Hold depressed until gas is on fire
- Release the knob and set the required flame size.



Ensure that no drafts or wind can blow out the flame when on a low setting.

Using cooktops with leak protection (Zt)

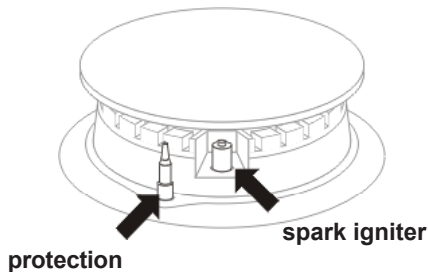

For your safety all Amica gas hob models are fitted with safety thermocouples.

The purpose of a thermocouple is to switch off the gas supply to the burner where no flame is detected.

Normal use of such system is very easy, simply hold the burner's control knob depressed for approx. 10 seconds in Burner ON large flame position.

This period of holding the control knob allows the thermocouple to heat up and "sense" that there is a flame present. Should you release the control knob too early the flame will extinguish.

When using on a low setting ensure that no wind or drafts can blow out the flame



Repeat the attempt if the protection has not activated for the first time.

Leak protection will cut off the gas supply if there is no flame for approx. 60 seconds. Ensure that no drafts or wind can blow out the flame when on a low setting.

OPERATION

What to do if surplus gas leak occurs

- 1 – gas network
- 2 – gas cut off valve
- A – valve ON
- B – valve OFF

Fig.9

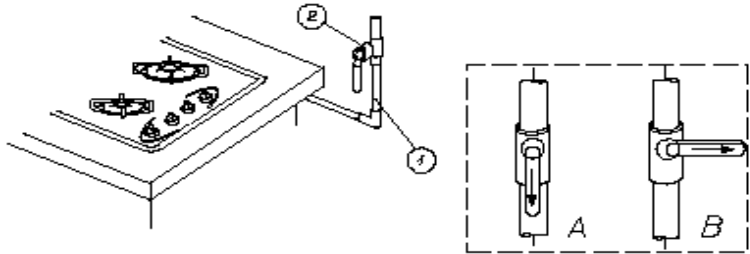

In any emergency, proceed as follows:

- turn the burners off
- set the cut off valve OFF (see fig. 9 B)
- ventilate the kitchen
- report the unit for repair at a service department of a licensed and authorised repair shop
- refrain from using the appliance until it is returned to its operating condition



NOTE

The user can fix some minor malfunctions himself, by following the instructions given in this manual.

The burner does not ignite, and gas is smelt;

- Close burner control knobs
- Close the gas mains / supply cut off valve
- Ventilate the kitchen
- Take the burner out of the hob
- Clean and blow the slots
- Insert the burner back in place
- Resume ignition attempt.

If the burner still fails to go on, report for a authorised repair.

CLEANING AND ROUTINE MAINTENANCE

For gas on glass models:

Daily cleaning and proper maintenance have crucial impact on the durability of your ceramic plate.



Clean the ceramic plate observing the same rules as for glass. Never use abrasive or aggressive cleaning agents, scrubbing powders or scratching sponges.

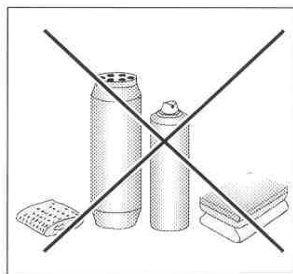

Burners, the burner hob grate.

- In the case of soiled burners and grate, these elements must be removed from the cooker and washed with warm water and washing – up products intended for fats and soils. Next, wipe them dry. After the grate has been removed, wash the burner hob carefully and wipe with a dry and soft cloth. In particular, ensure flame openings in rings under caps are clean, see the figure below. Do not use steel wire or drill holes.



Burner elements must always be clean. Water particles may hamper gas flow and produce an incorrect burner flame.

Fig. 10

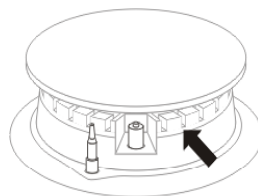

Hop Top (Depending on your hob top):

- Clean the enamel coated work panel only with warm water with a mild solution of dishwashing liquid. Use mild a detergent to remove otherwise resistant contamination.
- Clean the stainless steel panel thoroughly before you start to use the appliance. Particularly, remove the remaining of the protective foil adhesive and packaging tape adhesive. Clean the cooktop regularly each time after use. Do not allow the work panel to become very dirty, especially do not let spill-over stains to remain on the surface for long. We recommend Helios & Chromol cleaning agents for preliminary and regular cleaning of the stainless steel hob.

TROUBLESHOOTING

In each case, proceed as follows:

- Turn the burners off
- Disconnect power supply
- Report for repair
- The user can fix some minor malfunctions himself, according to the guidance given in the tables below. Please check the information below before contacting the service department.

PROBLEM	CAUSE	REMEDIES
1.The appliance does not work	- power cut	- check the home power fuse, replace if needed
2.Burner will not ignite	- flame slots contaminated	- close the gas cut off valve, close burner control knobs, ventilate the kitchen, take the burner out of the cooktop, blow and clean the flame slots
3.Igniter does not work	- power cut	- check the home power fuse, replace if needed
	- gas supply off	- open gas cut off valve
	- contaminated (caked) igniter	- clean the igniter
	- control knob released too soon	- hold the control knob depressed until the flame goes on and persists
4.Burner extinguishes	- control knob released too soon	- hold the control knob depressed until the flame goes on and persists

For any other issue please contact our service department for advice

Amica

 Service Help Line

For the UK: please call **0844 815 8880**

For Ireland: please call **0818 46 46 46**