



ADC 8B LCW

OPERATING INSTRUCTIONS

DRYER

Please carefully read these Operating Instructions before using the appliance!

CONTENTS

Basic Information.....	3
Safety instructions.....	4
Installing the dryer.....	8
Understanding the symbols on clothes labels.....	11
Display and control panel.....	12
Using the appliance.....	15
Table of programmes.....	16
Troubleshooting.....	17
Maintenance and Cleaning.....	19
Specification.....	20
Service and Warranty.....	20
Product fiche.....	21



In accordance with European Directive **2012/19/EC** and Polish legislation regarding used electrical and electronic goods, this appliance is marked with the symbol of the crossed-out waste container.

This marking indicates that the appliance must not be disposed of together with other household waste after it has been used.

The user is obliged to hand it over to waste collection centre collecting used electrical and electronic goods. The collectors, including local collection points, shops and local authority departments provide recycling schemes. Proper handling of used electrical and electronic goods helps avoid environmental and health hazards resulting from the presence of dangerous components and the inappropriate storage and processing of such goods.

BASIC INFORMATION

Dear customer,

From today, DRYING will be easier than ever before. Your Amica DRYER is exceptionally easy to use and extremely efficient. After reading these Operating Instructions, operating the appliance will be easy.

Before being packaged and leaving the manufacturer, the appliance was thoroughly checked with regard to safety and functionality. After these tests some moisture or water may remain in the appliance.

Before using the appliance, please carefully read these Operating Instructions

By following these instructions carefully you will be able to avoid any problems in using the appliance.

It is important to keep these Operating Instructions and store them in a safe place so that they can be consulted at any time.

Follow these instructions carefully in order to avoid possible accidents.



Important!

This dryer is intended for household use only for drying textiles and clothing.

Level the appliance before connecting it to a wall socket.

The manufacturer reserves the right to introduce changes, which do not affect operation of the appliance.

Use

- Carefully read the instructions below before using the appliance.
- Never use the appliance outdoors or anywhere the temperature may fall below freezing.
- The appliance should not be operated by children or anyone who has not read the instructions.

Important! Temperatures below 0°C can damage the appliance!

In the event of the appliance being stored or transported in sub-zero temperatures, it should be left to acclimatise in a temperature above 0°C for 8 hours before being used.

Manufacturer's Declaration

The manufacturer hereby declares that this product meets the requirements of the following European directives:

- Low Voltage Directive **2014/35/EU**,
- Electromagnetic Compatibility (EMC) Directive **2014/30/EU**,

and has been marked with the **CE** symbol and issued with a declaration of compliance made available to market regulators.

NOTES ON SAFETY

- This product is an electrical appliance that is used exclusively for indoor drying fabrics washed in water. Use of safe power supply during the operation!
- The power source must be grounded. The grounding cable must be buried underground and must not be connected to the utilities network, such as water pipe or gas pipe. Grounding and neutral wire and must be distinguished and may not be connected together.
- The power cord must comply with IEC standards and withstand current greater than 10A. If these requirements are not met, you should immediately adapt your domestic electrical system to ensure the safety of your household.
- The appliance can dry up to 8 kg of washed laundry.
- Do not dry chemically cleaned clothes in the dryer
- Do not dry dirty laundry.
- Laundry contaminated with substances such as cooking oil, acetone, alcohol, petrol, kerosene, stain removers, turpentine, wax and wax removers must be washed in warm water with detergent before drying in the dryer.
- Do not attempt to dry the foam rubber (latex foam), bathing caps, waterproof textiles, rubber-lined clothing or pillows fitted with rubber pads in your tumble dryer.
- Fabric softeners or similar products should be as specified in the relevant directions for use.

NOTES ON SAFETY

- Laundry is not heated in the last part of the drying cycle. It is the cooling cycle to make sure the laundry is not damaged and has the right temperature.
- Filters should be cleaned each you use the appliance.
- Always keep the appliance clean.
- The room where the appliance is used must have adequate ventilation. Do not install the appliance in the same room where you use other appliances that produce exhaust fumes and other combustion gases.
- **CAUTION:** Do not turn off the dryer before the drying cycle ends unless the laundry will be quickly removed and hung out in order to dissipate heat.
- Air from the appliance must not be discharged to a chimney used for discharging flue gas from combustion appliances that burn gas or other fuels.
- The appliance must be installed in such a way as to ensure unlimited access to it and the dryer door may be fully opened.
- Keep pets away from the machine.
- Laundry contaminated with oil may ignite spontaneously, especially in the heat generated in a tumble dryer. Heating oil causes oxidation reaction. The oxidation produces additional heat. If the heat cannot dissipate, the laundry can become hot enough that ignition occurs. Stacking fabrics soiled with oil can prevent heat dissipation and create a fire hazard.

NOTES ON SAFETY

- If you cannot avoid tumble drying fabrics soiled with vegetable oil, cooking oil or dirty hair care products, you must first wash dirty laundry in hot water with detergent. In this way you can reduce, but not eliminate the risk.
- Do not overturn the appliance during normal use and maintenance.
- Before drying, make sure there are no foreign objects such as coins, lighters, matches, etc. in clothing pockets.
- This appliance can be used by children aged 8 years and older or persons with physical, mental or sensory handicaps, or those who are inexperienced or unfamiliar with the appliance, provided they are supervised or have been instructed how to safely use the appliance and are familiar with the associated risks. Ensure that children do not play with the appliance. Children should not be allowed to clean or maintain the appliance.

Children less than 3 years of age shall be kept away unless continuously supervised.

- If the power cord is damaged it must be replaced to prevent danger. The power cord can be replaced by a service centre authorized by the manufacturer or by other suitably qualified person.
- This appliance is intended solely for indoor use.
- Make sure any dryer ventilation openings are not blocked by the carpet.

NOTES ON SAFETY

- If the appliance excessively heats up, immediately remove the plug from the wall outlet.
- Do not pull the power cord when removing the plug from the wall outlet.
- Do not insert or remove the plug from the wall outlet with wet hands.
- Do not damage the cord or plug.
- Do not install or disassemble the dryer before you carefully read the operating instructions.
- Do not place the dryer on top of the washing machine without a special kit (You must purchase the stacking kit to install the dryer on top of the washing machine. To avoid the danger hair the dryer must by installed the manufacturer's service technician or other suitably qualified person).
- Do not lean on the open dryer door.
- Do not place objects such as candles or electric stove on the dryer.
- Do not exceed the maximum appliance load.
- Do not use the dryer without the filter base and its cover.
- Do not dry wet laundry that has not been spun.
- Do not expose the dryer to direct sunlight. The appliance is designed for household use only.
- Do not install dryer in rooms with high humidity.
- Unplug the appliance from the wall outlet before any cleaning and maintenance. Do not clean the appliance with water jet.
- Do not dry laundry contaminated with flammable substances, such as oil or alcohol. This could result in an explosion.

INSTALL THE DRYER

I. Position and level the appliance



- For convenience, it is recommended to place the appliance near a washing machine.
- Do not place the appliance on a carpet!
- The dryer must be installed in a clean place, where dirt does not accumulate. There must be free air circulation around the appliance. Do not block the front air inlet or air intake grilles at the back of the appliance.
- The floor surface should not be either concave or sloping!
- Pay attention to the shape of the floor surface, and make sure the entire appliance weight rests on its legs (not its body)!

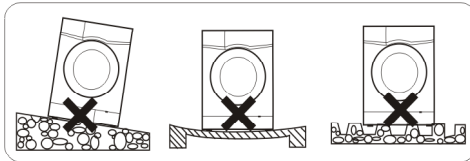

- Place the appliance on a solid, even surface.
- Level the machine by adjusting the legs (1)



After positioning and levelling the appliance, check that it is stable by pressing down each corner and ensuring it does not move!

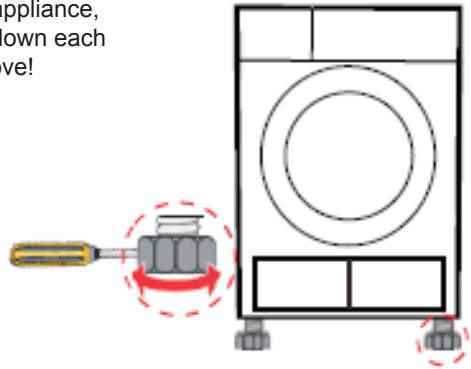

INSTALL THE DRYER

II. Water drain (option)

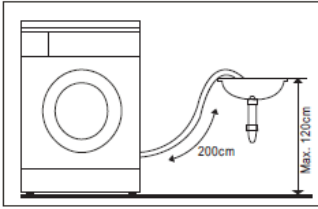

Normally condensed water drains into the container in the upper left corner of the dryer. Optionally, you can use the drain hose in the accessory bag and connect it to the dryer. Connect the hose as shown here.

III. Connect to power supply

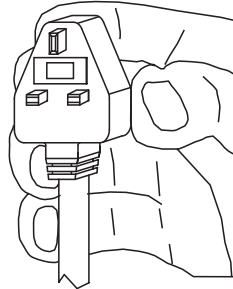
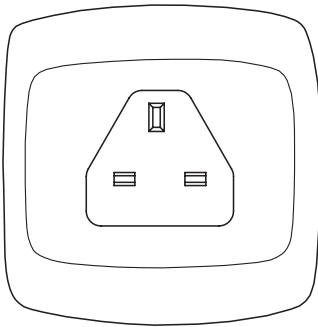











- The appliance's mains connection (electrical wall socket) should be in a visible and accessible place!
- Only plug the appliance into a properly installed socket with an earth pin!
- Do not connect the appliance through any extension cord or an adapter!
- In the event of the power cord being damaged, it must be replaced by an authorised technician.
- The electrical system to which the appliance is to be connected must be protected with a 10 A fuse.

INSTALL THE DRYER













IV. Tips

1. Spin the laundry in the washing machine before tumble drying. The high spin speed can reduce the drying time and save energy.
2. To make sure the drying effects are uniform, sort the laundry by fabric type and drying program.
3. Before the drying close the locks, hooks and buttons, etc.
4. Do not over-dry clothes, as they can easily crease or shrink.
5. Do not dry articles such as raincoats, bike covers or similar flexible materials containing rubber parts.
6. The door can only be opened when the programme completes. This prevents the user from being scalded by hot steam or overheated air.
7. To avoid extended drying cycles and increased energy consumption, clean the appliance filters after each use. Remember to empty the container with water discharged during drying.
8. Use only the dedicated programme to dry woollen garments.
9. Recommended load depending on the kind of laundry to be dried.

Coats (approx. 800 g) 	Jackets (about 800g cotton) 	Jeans (approx. 800 g) 	Quilts (about 900g cotton) 
Sheets (about 600g cotton) 	Working clothes (upper and lower) (about 1120g cotton) 	Pyjamas (approx. 200g) 	Shirts (about 300g cotton) 
T-shirts (about 180g cotton) 	Briefs, panties (about 70g cotton) 	Socks (about 30g fiber mix) 	

UNDERSTANDING THE SYMBOLS ON CLOTHES LABELS

Before drying pay attention to the symbols on the apparel label.
 Failure to follow the symbol instructions may damage or destroy clothes to be dried.
 The symbols are explained in the following table:

Dry 	Tumble dry 	Do not tumble dry 	Do not dry 
Line dry/hang to dry 	Drip dry 	Dry flat 	Dry in the shade 
Dry clean 	Do not dry clean 	Dry clean normal cycle with any solvent 	Dry clean normal cycle petroleum solvent only 

Dryer description

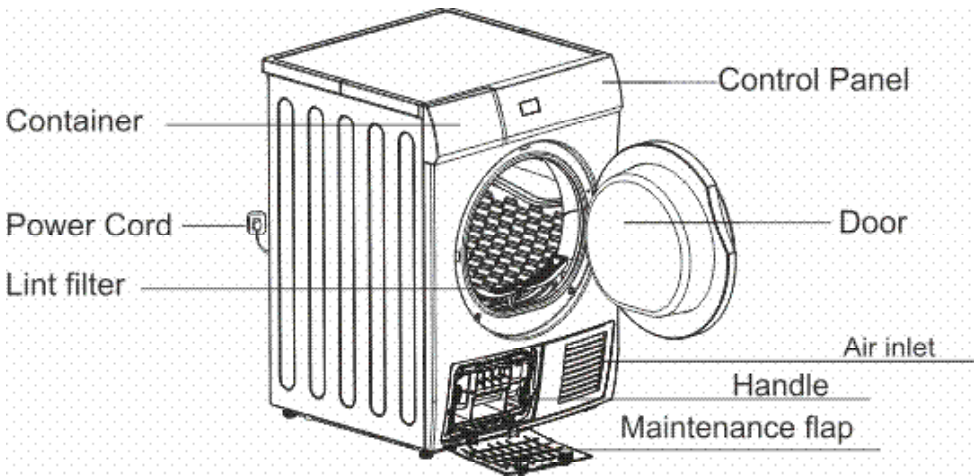

DISPLAY AND CONTROL PANEL

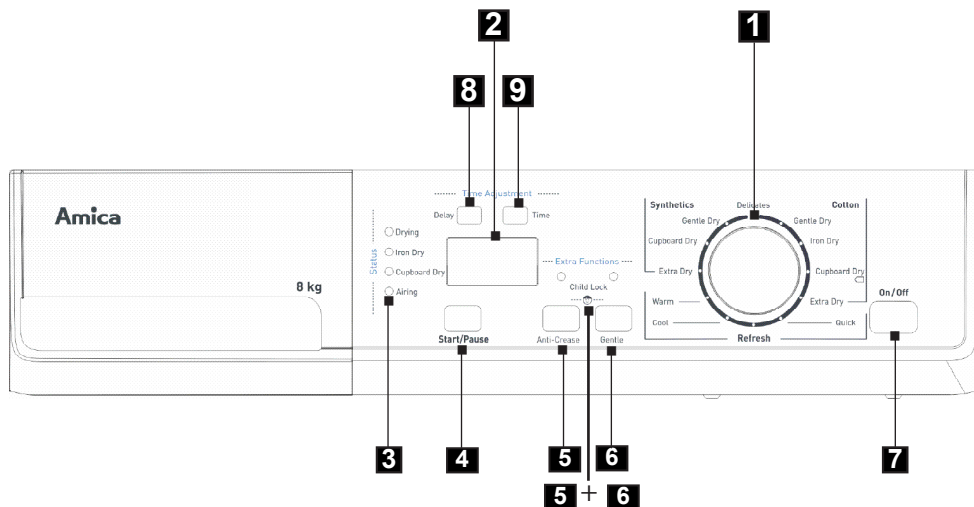

1. Programme selector dial
2. Display
3. Indicators of progress of the program (Drying, Iron Dry, Cupboard Dry, Airing)
4. **Start/Pause** button
5. **Anti-Crease** button
6. **Gentle** button
7. **On/Off** button
8. **Delay** button
9. **Time** button
- 5 + 6. **Child Lock**

DISPLAY AND CONTROL PANEL

1. Programme selector dial

Choose the appropriate drying programme as required, depending on the type and amount of laundry loaded, which ensures better results and more effective drying. Once the drying programme is started, turning the programme selector knob to another position is possible, however it does not change the previously selected programme.

2. Display

The display shows the remaining time / delay time / error message, soiled filter indicator (caution), water tank full indicator (caution), Child Lock indicator.

- Only light (DELAY / REMAIN) relevant to the phase that is currently being carried out will remain display during the drying process.
- When the drying procedure begins, REMAIN will display the remaining time, that is, the drying procedure will finished in [x:xx] time.
- The display “- ”means programme in “standby” status, you can press any buttons or open the door to awaken programme.

3. Indicators of progress of the program

The four LED lights indicate the status of the drying procedure.

4. START/PAUSE button

Press **Start/Pause** to start or pause a programme.

When this button is pressed, this machine is switched between start and pause.

5. Anti-Crease button

At the end of the drying cycle, the “Anti-Crease” phase time is 30 minutes (default) or 120 minutes (selected), when the anti-crease function is selected in all of the drying programme, the LED of anti-crease shall illuminate, and the drum will intermittent rotate during the drying programme , in order to give more care to ensure the sensitive textiles can not get crease. Except [Warm], [Cool] and [Refresh] ,all the other programmes have this function.

6. Gentle button

When the gentle function is selected except “Refresh”, “Cool” and “Warm”, the display time shall be to add 20 minutes, the LED of gentle shall illuminate, and the programme will give less heat to protect sensitive textiles from high temperature which may harm to these textiles, such as acetate, elastane and etc.

7. On/Off button

On/Off button has the on and off function. When this button is pressed, this machine is switched between on and off.

DISPLAY AND CONTROL PANEL

8. Delay button

This function is used to delay clothes drying within 24 hours. You can press this key continuously; it can be selected within 1-24 hours. The delay time means drying procedure will start in x:xx hours.

When the delay procedure starts, the display will only show the delay start time and flash DELAY icon. After 30s, the display will only show “-”.

9. Time button

This function can set the time of drying procedure by your self; the time can be adjusted from 20 to 60 minutes by press “Time” button. This function special designed for few small clothes, for example, one facecloth or two pairs of socks.

It's like using timer to control drying process, but only for [Warm] programme.

5 + 6. Child Lock

This function prevents children from changing settings or interrupting appliance operation. Pres and hold **Gentle** and **Anti-Crease** button for 3 seconds to activate the Child Lock during a drying cycle. When child lock function is set, the display will show  icon and only [On/Off] button can be used. To disable Child Lock, press and hold Gentle and Anti-Crease buttons for 3 seconds.

Important! If the Child Lock function is activated, the display will show the  symbol.

Important! When you turn off or unplug the dryer or the drying cycle ends, the Child Lock function will deactivate.

USING THE APPLIANCE

I. Select Programme

1. Press [On / Off]. When the LED display lights up turn the programme selection dial and select the desired programme
2. Select the additional option [Delay], [Time], [Gentle] or [Anti-Crease] — if the programme allows you to select additional options.
3. Press the [Start/ Pause] button.

II. Set Delay Start

The delayed start function may be used when, for example, taking advantage of discounted electricity tariffs.

Procedure:

1. Close the appliance door.
2. Set the programme selector knob to the desired programme (see the table further on).
3. Select additional functions or drying cycle parameters as required.
4. Press the Delay Start button.
5. Select time ranging from 1 to 24 hours. The display will show the setting from 1H to 24H.
6. Press the [Start/ Pause] button. The appliance will be set in delay mode. Drying cycle will commence immediately after the delay time has elapsed.

Note: If you set delay start, the display will show the time remaining to start the drying program.

III. End of drying cycle

1. Once the programme has completed, the drum stops rotating and the display shows "0:00". The last programme phase indicator will flash. If you do not remove clothes from the dryer with a specified time, the appliance will start the [Anti-Crease] programme. Press [On/Off] and remove the plug from the wall outlet.
2. If the appliance suddenly stops during the drying programme and displays an error message, follow the information in the "Troubleshooting" section.

IV. Cancel or modify programme

Press the On/Off button to interrupt the programme. Then press on/off button again to turn on the appliance and select the desired drying programme.



TABLE OF PROGRAMMES

Programme name	Weight (Max) Kg	Additional functions available				Recommendations	Time [H:min]	Energy consumption [kWh]	
		Delay	Time	Anti-Crease	Gentle				
Cotton	8	1-24H	X	Y	Y	For cottons and coloureds made of cotton or linen	01:30	3,9	
		1-24H	X	Y	Y		01:05		3,0
		1-24H	X	Y	Y		02:10		4,9
		1-24H	X	Y	Y		02:30		5,5
		1-24H	X	Y	Y				
Synthetics	3,5	1-24H	X	Y	Y	To dry thin synthetic fabrics which are also to be hanged or ironed, such as knitwear, shirts. Drying level: applicable to hang or iron. To dry thin synthetic fabrics which are not ironed, such as easy care shirts, table linen, baby clothes, socks. Drying level: outdoor dry. To dry thick or multi-layered synthetic fabrics. Drying level: extra dry.	00:42	1,2	
		Standard	X	Y	Y		00:57		1,6
		Extra	X	Y	Y		01:00		1,8
		Delicate	X	Y	Y		01:00		2,0
		Warm	Y	X	X		00:20		0,7
		Cool	X	X	X		00:30		0,1
		Quick	X	Y	Y		01:05		2,8
Refresh	X	X	X	00:32	0,4				

Note: the above programme is only recommended for use, the user can according to personal habits to choose the right programme.
 Thick or multi-layered fabrics e.g. bedlinen, jeans, jackets etc. are not easy to dry. You'd better choose Cotton Extra programme.

TROUBLESHOOTING

1. Empty the water container after each use, the programme will be paused and the  icon will flash if the water container is full during the drying process. After the container emptied, the dryer can be restarted by pushing [Start/Pause] button.
2. Do not drink the condensed water.



Alarm Problem	Alarm Reason	Buzzer Alarm	Release
 is flashing	Water tank full or pump error		Check the water tank and pump.
 is flashing	Air flow block		Check the filter and the air folw
E30	Heater problem	The Error Code is flashing on X:XX at Flash Rate 1. Meanwhile the beep is sounded every 15 minutes.	Check the heater and the thermostat
E32	Humidity sensor error		Check the Humidity sensor and PCB
E33	Temperature sensor error		Check the front temperature sensor
E34			Check the rear temprature sensor

TROUBLESHOOTING

Appliance error codes

The tumble drier indicates error codes to help locate minor operating faults and identify their cause. The ERROR CODES help locate and determine the cause.

Detected errors are indicated as shown in the following table:

Problem	Solution
● Display does not come on	<ul style="list-style-type: none">● The mains plug is inserted.● Check the programme selected.● Check fuse in the house.
 is flashing	<ul style="list-style-type: none">● Empty condensation container.● If failure, check hose for condensation outlet.
 is flashing	<ul style="list-style-type: none">● Clean air cooler.● Clear lint filter.
● Dryer does not start	<ul style="list-style-type: none">● Check the start button has selected.● Check the door has closed.● Check the programme has set.
● Water is running out	<ul style="list-style-type: none">● Align dryer horizontally.● Clear air condenser and door seals.
● Door is open by itself	<ul style="list-style-type: none">● Press door until it “clicks” into position.● Check the clothes is over load.
● Humidity in the room is increase significantly	<ul style="list-style-type: none">● Ventilate room adequately.● Clean the cool grille.● Ensure that the air condenser has been inserted.
● Degree of dryness was not reached or drying time too long	<ul style="list-style-type: none">● Clean lint filter and wash condenser.● Empty container.● Check water outlet.● Dryer installation too restricted.● Clean the moisture sensors.● Use next higher drying programme or using● Timer programme.

When an error occurs, the appliance beeps (if active).

If you cannot deal with the fault by yourself and need help:

1. Press the [On/Off] button.
2. Pull out the mains plug and call the service.

MAINTENANCE AND CLEANING

I. Empty the water container

1. Hold and pull out the water container with two hands.
2. Tilt the water container, pour out the condensed water.
3. Insert the water container.

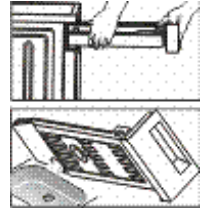

II. Clean the lint filter

Leave the dryer to cool down

1. Open the machine door.
2. Take out the lint filter, pull upward to take it out.
3. Clean the lint filter; wipe off the scrap threads accumulated on the lint filter, with your hand or rinse with water and dry thoroughly.
4. Reinstall the lint filter.

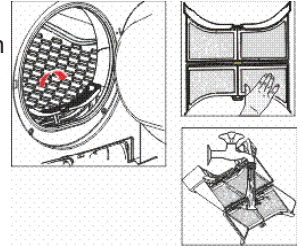

NOTE!

1. The lint filter accumulated on the filter will block the air circulation, which will cause the extension of drying time and energy use; therefore, the scrap thread filter shall be cleaned after each use.
2. Do disconnect the power cord before cleaning!
3. Do not operate the dryer without the lint filter !
4. Clean the lint filter after each use to prevent lint accumulation inside the dryer.

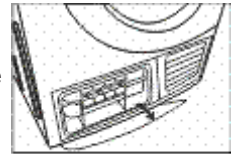

Wash air condenser

-Leave the dryer to cool down.

-Residual water may escape, place an absorbent cloth under the maintenance flap.

1. Unlock the maintenance flap.
2. Completely open maintenance flap.
3. Screw both locking levers towards each other.
4. Pull out the air condenser.
5. Clean the air condenser completely, drain thoroughly.
6. Clean the seals.
7. Re-insert the air condenser, handle at the button!
8. Unscrew both locking levers.
9. Close the maintenance flap until it locks into position.

Please clean the air condenser approx, once every 3 months if frequently used.
Do not damage the air condenser !

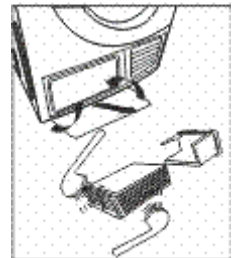
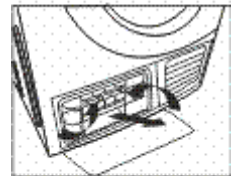

1. Clean with water only; do not use hard/sharp-edged objects! Do not operate the dryer without the air condenser!

2. During drying, water may collect between the window and the seal, but this does not affect the function of your dryer!

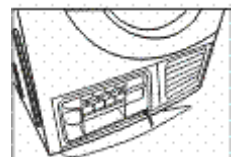

SPECIFICATION

-Type	ADC 8B LCW
-Rated voltage	220-240V / ~ 50Hz.
-Rated power	2700 W
- Ambient temperature	+ 5°C ~+ 35°C
- Maximum Load	max 8 kg
- Dimensions Height x Depth x Width	845/595/615 [mm]
- Weight	43 kg
Meets the requirements of EU legislation, EN- 61121 standard	

Note:

- 1.The rated capacity is the maximum capacity, make sure that the dry clothes which are loaded to the appliance do not exceed the rated capacity each time.
- 2.Do not install the tumble dryer in a room when there is a risk of frost occurring. At temperatures around freezing point the tumble dryer may not be able to operate properly.
- 3.There is a risk of damage if the condensed water is allowed to freeze in the pump, hoses and / or condensed water container.

Testing for label information in accordance with EN 61121 using the standard cotton drying programmes:

- at full load
- at partial load

- weighted average electricity consumption is **561** kWh/year

Amica

 Service Help Line

For the UK: please call
0844 815 8880 (non-geographic number)
or **01563 557158** (standard rate call)

For Ireland: please call
0818 46 46 46 (non-geographic number)
or **01 842 8222** (standard rate call)

PRODUCT SHEET

(In accordance with Commission Delegated Regulation (EU) No. 392/2012 of 1 March 2012 supplementing Directive 2010/30/EU of the European Parliament and of the Council with regard to energy labelling of household tumble dryers).

Supplier's name or trade mark	Amica
Type	ADC 8B LCW
Rated load	8.0 kg
Energy efficiency class ¹⁾²⁾	B
Dryer Type	condensing
Annual weighted average energy consumption AE_c ³⁾	561 kWh / year
Energy consumption of the standard cotton drying programme:	
- At full load E_{dry}	4.74 kWh
- At partial load $E_{dry1/2}$	2.56 kWh
Power consumption in the off-mode P_o	0.28 W
Power consumption in standby mode P_l	0.80 W
Duration of the left-on mode:	10 min
Condensation efficiency class on a scale from G (lowest efficiency) to A (highest efficiency) ¹⁾	B
The average condensation efficiency in the standard cotton programme at full load C_t	80%
The average condensation efficiency for the standard cotton programme at partial load C_{dry}	80%
The weighted condensation efficiency for the standard cotton programme at full and partial load $C_{dry1/2}$	80%
The weighted duration of the standard cotton programme at full and partial load T_t	112 min.
Duration of the standard cotton programme at full load T_{dry}	140 min.
Duration of the standard cotton programme at partial load $T_{dry1/2}$	90 min.
Sound level in the standard cotton program at full load L_{wa}	69 dB (A) re 1 pW
Equipment designed for fitting	No
Automatic tumble dryer	No

¹⁾ Energy efficiency class on a scale from A+++ (more efficient) to D (least efficient)

²⁾ "Standard cotton drying programme" is the programme referred to on label and in the datasheet — it is suitable for drying cotton at normal humidity levels and is the most energy efficient programme for drying cotton.

This programme is suitable for drying normal, wet cotton products.

It is the most energy efficient cotton drying programme.

³⁾ Estimated weighted annual energy consumption based on 160 standard cotton drying cycles at full and partial load and power consumption in standby and off modes.

Actual energy consumption depends on how the appliance is used.

The dryer is equipped with a power management system. Standby time 1 minute.

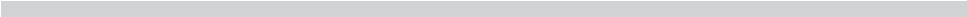



Amica

 Service Help Line

For the UK: please call
0844 815 8880 (non-geographic number)
or **01563 557158** (standard rate call)

For Ireland: please call
0818 46 46 46 (non-geographic number)
or **01 842 8222** (standard rate call)