

Amica

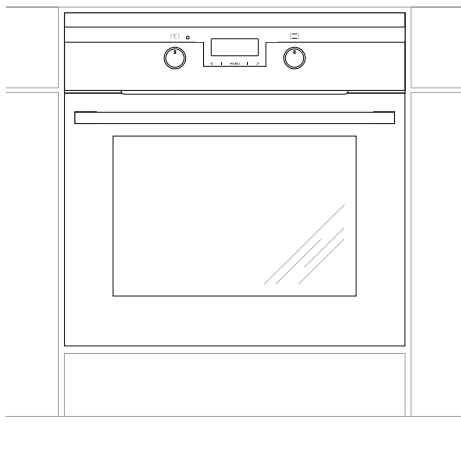

TYPE

10147.3eETsDbHaScJQaW
10147.3eETsDbHaScJQaS
10147.3eETsDbHaScJQaXSp

MODEL

ASC420WH/1
ASC420BL/1
ASC420SS/1

INSTRUCTION MANUAL

BUILT-IN ELECTRIC OVEN



DEAR CUSTOMER,

The oven is exceptionally easy to use and extremely efficient. After reading the instruction manual, operating the oven will be easy.

Before being packaged and leaving the manufacturer, the oven was thoroughly checked with regard to safety and functionality.

Before using the appliance, please read the instruction manual carefully.

By following these instructions carefully you will be able to avoid any problems in using the appliance.

It is important to keep the instruction manual and store it in a safe place so that it can be consulted at any time.

It is necessary to follow the instructions in the manual carefully in order to avoid possible accidents.

Caution!

Do not use the oven until you have read this instruction manual.

The oven is intended for household use only.

The manufacturer reserves the right to introduce changes which do not affect the operation of the appliance.

TABLE OF CONTENTS

Safety instructions	4
Description of the appliance	8
Operation	10
Baking in the oven – practical hints	16
Test dishes	19
Cleaning and maintenance	21
Installation instructions	24
Specifications	28

SAFETY INSTRUCTIONS

Warning: The appliance and its accessible parts become hot during use. Care should be taken to avoid touching heating elements. Children less than 8 years of age shall be kept away unless continuously supervised.

This appliance can be used by children aged from 8 years and above and persons with reduced physical, sensory or mental capabilities or lack of experience and knowledge if they have been given supervision or instruction concerning use of the appliance in a safe way and understand the hazards involved. Children shall not play with the appliance. Cleaning and user maintenance shall not be made by children without supervision.

During use the appliance becomes hot. Care should be taken to avoid touching heating elements inside the oven.

Accessible parts may become hot during use. Young children should be kept away.

Warning: Do not use harsh abrasive cleaners or sharp metal scrapers to clean the oven door glass since they can scratch the surface, which may result in shattering of the glass.

SAFETY INSTRUCTIONS

Warning: Ensure that the appliance is switched off before replacing the lamp to avoid the possibility of electric shock.

You should not use steam cleaning devices to clean the appliance.

- Ensure that small items of household equipment, including connection leads, do not touch the hot oven as the insulation material of this equipment is usually not resistant to high temperatures.
- Do not leave the oven unattended when frying. Oils and fats may catch fire due to overheating or boiling over.
- Do not put pans weighing over 15 kg on the opened door of the oven.
- Do not use harsh cleaning agents or sharp metal objects to clean the door as they can scratch the surface, which could then result in the glass cracking.
- Do not use the oven in the event of a technical fault. Any faults must be fixed by an appropriately qualified and authorised person.
- In the event of any incident caused by a technical fault, disconnect the power and report the fault to the service centre to be repaired.
- The rules and provisions contained in this instruction manual should be strictly observed. Do not allow anybody who is not familiar with the contents of this instruction manual to operate the oven.
- The appliance has been designed only for cooking. Any other use (for example for heating) does not comply with its operating profile and may cause danger.

HOW TO SAVE ENERGY



Using energy in a responsible way not only saves money but also helps the environment. So let's save energy! And this is how you can do it:

- **Do not uncover the pan too often (a watched pot never boils!).**

Do not open the oven door unnecessarily often.

- **Switch off the oven in good time and make use of residual heat.**

For long cooking times, switch off heating zones 5 to 10 minutes before finishing cooking. This saves up to 20% on energy.

- **Only use the oven when cooking larger dishes.**

Meat of up to 1 kg can be prepared more economically in a pan on the cooker hob.

- **Make use of residual heat from the oven.**

If the cooking time is greater than 40 minutes switch off the oven 10 minutes before the end time.

Important! When using the timer, set appropriately shorter cooking times according to the dish being prepared.

- **Make sure the oven door is properly closed.**

Heat can leak through spillages on the door seals. Clean up any spillages immediately.

- **Do not install the oven in the direct vicinity of refrigerators/freezers.**

Otherwise energy consumption increases unnecessarily.

UNPACKING



During transportation, protective packaging was used to protect the appliance against any damage. After unpacking, please dispose of all elements of packaging in a way that will not cause damage to the environment.

All materials used for packaging the appliance are environmentally friendly; they are 100% recyclable and are marked with the appropriate symbol.

Caution! During unpacking, the packaging materials (polythene bags, polystyrene pieces, etc.) should be kept out of reach of children.

DISPOSAL OF THE APPLIANCE



Old appliances should not simply be disposed of with normal household waste, but should be delivered to a collection and recycling centre for electric and electronic equipment. A symbol shown on the product, the instruction manual or the packaging shows that it is suitable for recycling.

Materials used inside the appliance are recyclable and are labelled with information concerning this. By recycling materials or other parts from used devices you are making a significant contribution to the protection of our environment.

Information on appropriate disposal centres for used devices can be provided by your local authority.

DESCRIPTION OF THE APPLIANCE

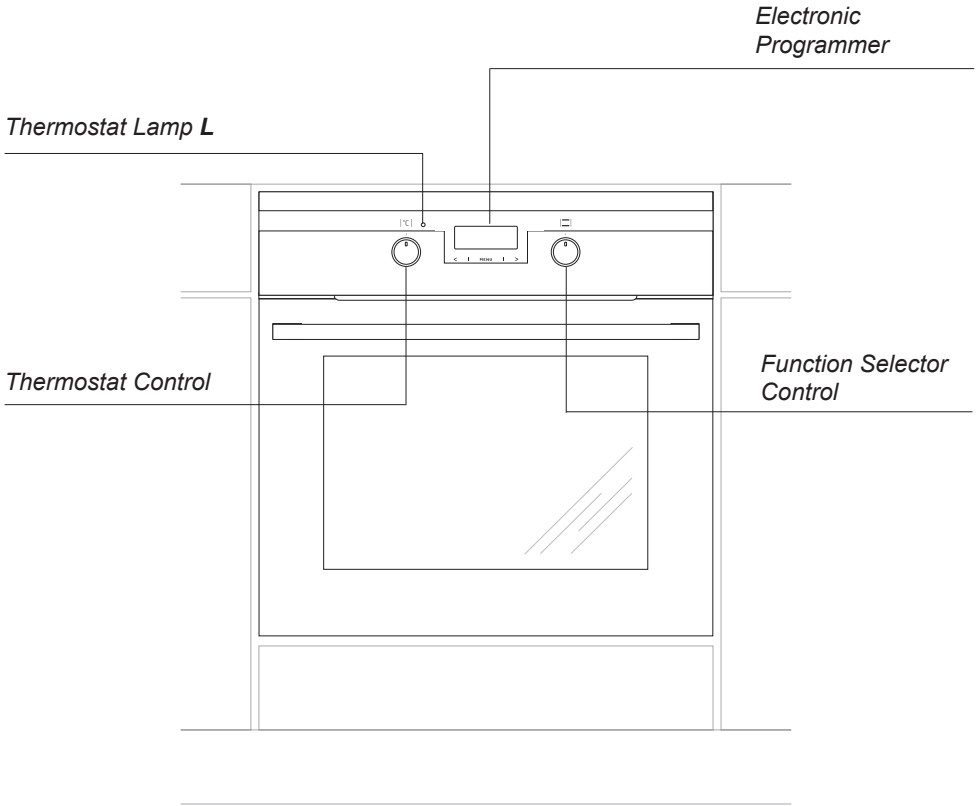

SPECIFICATIONS OF THE APPLIANCE

Cooker fittings:

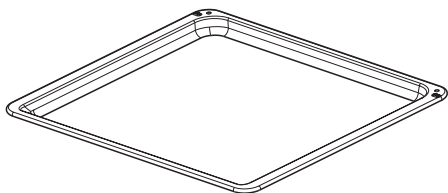

Baking tray

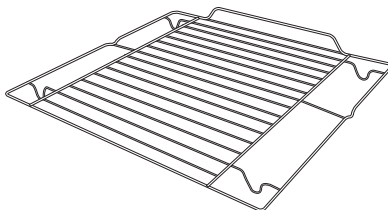

*Grill grate
(drying rack)*

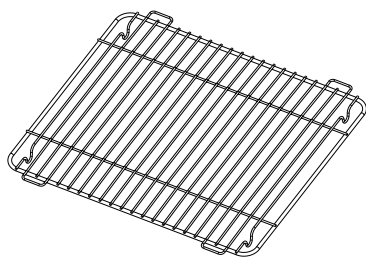

Grill Rack

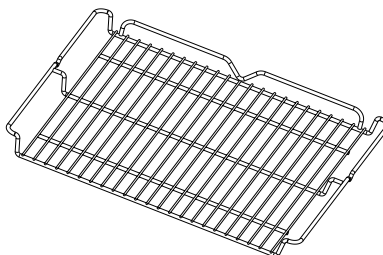

Wire Shelf

*All images are for indication only; please refer to your individual unit for actual item.

OPERATION

Before using the appliance for the first time

First start – preliminary cleaning

To remove residues of fat and oil accumulated during the manufacturing process and dust accumulated during storage and transport, the preliminary cleaning of the equipment should be carried out. This way our health is protected and tasty cakes and roasts are provided.

Caustic agents and abrasive powders should be avoided as they can damage the surface.

Preliminary heating

1. Remove packaging elements from the oven chamber.
2. Turn on ventilation in the room or open a window.
3. Start the oven at the temperature of 250°C.
4. Heat the oven for around 30 minutes.

The smell that is emitted during the first heating of the oven is connected with vapouring of residues of fat and oil used to protect the oven for the time of storing.

Important!

To clean the oven, only use a cloth well rang out with warm water to which a little washing-up liquid has been added.

Important!

In ovens equipped with the electronic programmer, the time “0.00” will start flashing in the display field upon connection to the power supply.

The programmer should be set with the current time. (See *Electronic programmer*). If the current time is not set operation of the oven is impossible.

The oven is equipped with a retractable knobs. In order to select a function do the following:

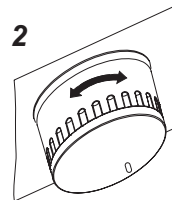
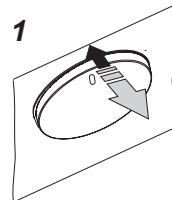

1. Gently press and release a knob which will pop out,
2. Turn the oven functions selection knob to the desired function.

Symbols printed around the knob indicate available oven functions.



OPERATION

Electronic programmer

   – function symbols

- MENU – Mode sensor
- < – Minus sensor
- > – Plus sensor

The electronic programmer is equipped with electronic sensors which are switched on by touching or pressing the sensor surface for at least one second.

Each sensor reaction is confirmed by the beep. Keep the sensor surface clean at all times.

Setting the time

After connection to the mains or reconnection after a power cut the display shows flash 0.00.



- Press and hold **MENU** (or simultaneously press < and >) until you will see  on the display and the dot below the symbol is flashing,
- Press < or > within 7 seconds to set the current time.

To store the new time setting, wait approximately 7 seconds after time has been set. The dot below the  symbol will stop flashing.

You can adjust the time later. To do this touch < and >, simultaneously and adjust the current time while the dot below the  symbol is flashing.

Timer

The timer can be activated at any time, regardless of the status of other functions. The timer can be set for from 1 minute to up to 23 hours and 59 minutes.

To set the timer you should:

- Press sensor **MENU**, then the display will show flashing ,

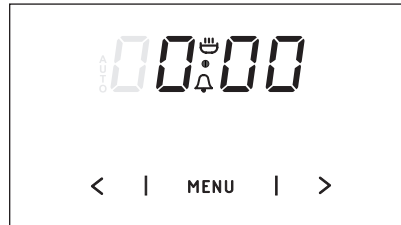

- set the timer using sensors > and <. The time set is shown on the display and the signal function  is on.
- Press sensor **MENU**, < or > in order to switch off the signal, the signal function will go out and the display will show the current time.

Caution!

If the alarm signal is not turned off manually, it will be turned off automatically after approx. 7 minutes.

OPERATION

Semi-automatic operation

If the oven is to be switched off at a given time, then you should:

- Set the oven function knob and the temperature regulator knob to the setting at which you want the oven to operate.
- Press sensor **MENU** until the display will show:



- Set the required time using sensors **>** and **<**, within a range from 1 minute to 10 hours.

The set time will be introduced to the memory after approx. 7 seconds and the display will show AUTO function.

When the set time has passed the oven is switched off automatically, the alarm signal is activated and the signal function AUTO flashing again;

- Set the oven function knob and the temperature regulator knob to the switched-off position.
- Press sensor **MENU**, **<** or **>** in order to switch off the signal; the signal function will go out and the display will show the current time.

Automatic operation

If the oven is to be switched on for a specified period of time and switched off at a fixed hour then you should set the operation time and the operation end time:

- Press sensor **MENU** until the display will show:



- Set the required time using the sensors **>** and **<** within a range from 1 minute to 10 hours.
- Press sensor **MENU** until the display will show:

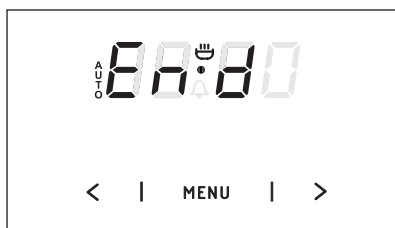

- Set the switch-off time (operation end time) using sensors **>** and **<**, which is limited to a period of 23 hours and 59 minutes from the current time.
- Set the oven function knob and the temperature regulator knob to the setting at which you want the oven to operate.

OPERATION

The function AUTO is now on; the oven will start operating from the point when the difference between the set operation end time and the operation duration time occurs (e.g. the operation time is set to 1 hour, the operation end time is set to 14.00, so the oven will start working automatically at 13.00).

When the oven reaches the operation end time it will switch off automatically, the alarm will be activated and the function AUTO will start flashing again.

- Set the oven function knob and the temperature regulator knob to the switched-off position.
- Press sensor **MENU** , < or > in order to switch off the alarm; the function AUTO will go out and the display will show the current time.

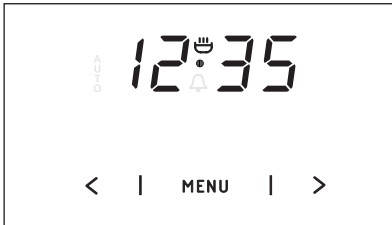

Cancel settings

Timer and automatic function settings may be cancelled at any time.

Cancel automatic function settings:

- press sensors < and > simultaneously,

Cancel timer settings:

- press sensor **MENU** to select timer settings,
- press sensors < and > again,

Change the timer beeps

The tone of the timer beeps may be changed as follows:

- press sensors < and > simultaneously,
- select "tone" function with the **MENU** sensor, the display panel will start to blink:

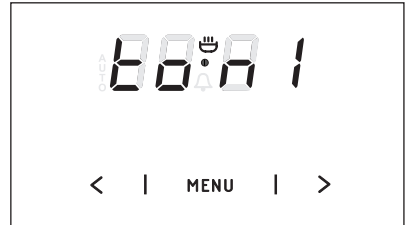

- with the < sensor press the appropriate sensors from 1 to 3 to select the option you wish.

OPERATION

Oven functions and operation.

The oven can be heated up using the top and bottom heater, the grill or the ultra-fan heater. Operation of the oven is controlled by the Function Selector Control – to set a required function you should turn the Control to the selected position, and the Thermostat Control – to set a required temperature you should turn the Control to the selected position.

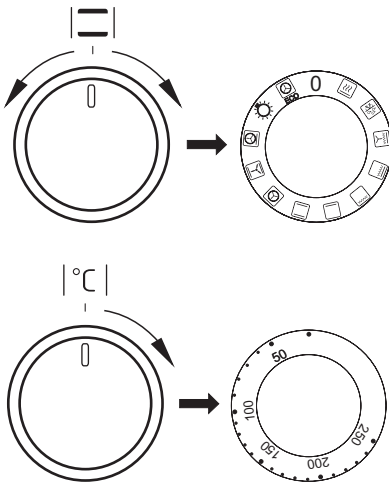

The oven can be switched off by setting both of these Controls to the position “●”/“○”.

Caution!

When selecting any heating function (switching a heater on etc.) the oven will only be switched on after the temperature has been set by the Thermostat Control.

0 Oven is off



Rapid Preheating

Top heater, grill and fan on. Use to preheat the oven.



Defrost

Only fan is on and all heaters are off.



Fanned full grill

This function radiates the heat from the grill element and the top element with fan.

This function allows the grilling process to be speeded up and an improvement in the taste of the dish.



Full grill

This function radiates the heat from the grill element and the top element.

This fully temperature variable grill is ideal for grilling a full family meal. It can be set between 50°C and 250°C maximum.



Half grill

This function radiates the heat from the grill element.

This fully temperature variable grill can be set between 50°C and 250°C maximum.



Bottom heater

This function radiates the heat from the bottom element. Baking of cakes from the bottom until done (moist cakes with fruit stuffing).



Top and bottom heaters

The thermostat enables the user to set the temperature within a range from 100°C to 250°C. Use for baking. This setting is ideal for baking cakes, meat, fish, bread and pizza (it is necessary to preheat the oven and use a baking tray) on one oven level.

OPERATION



Fan oven

Using the circular element and the fan with a temperature between 50°C and 250°C, this cooking function blows the air into and around the oven cavity.

Heating in this manner helps to ensure uniform heat circulation. Both cooking temperatures and cooking times can be reduced for a more energy efficient cooking process.



Top heater, bottom heater and fan

This setting is most suitable for baking cakes. Convection baking (recommended for baking).



Fan and bottom heater

With this setting the convection fan and bottom heater are on, which increases the temperature at the bottom of the cooked dish. Intense heat from the bottom, moist cakes, pizza.



Light

The oven light will be turned on.



ECO

ECO Heating

This is an optimised heating function designed to save energy when preparing food. At this knob position, the oven lighting is off.

The *Thermostat Lamp L* will be switched on after the temperature has been set by the Thermostat Control. If the **L** light goes out, it means the oven has reached the set temperature. If a recipe recommends placing dishes in a warmed-up oven, this should be not done before the **L** light goes out for the first time. When baking, the **L** light will temporarily come on and go out (to maintain the temperature inside the oven).

Use of the grill

The grilling process operates through infrared rays emitted onto the dish by the incandescent grill heater.

In order to switch on the grill you need to:

- Set the Function Selector Control to the position marked grill.
- Heat the oven for approx. 5 minutes (with the oven door shut).
- Insert a tray with a dish onto the appropriate cooking level; and if you are grilling on the grate insert a tray for dripping on the level immediately below (under the grate).
- Close the oven door.

For grilling with the function grill and combined grill the temperature must be set to 250°C, but for the function fan and grill it must be set to a maximum of 190°C.

Warning!

When using function grill it is recommended that the oven door is closed.

When the grill is in use accessible parts can become hot.

It is best to keep children away from the oven.

BAKING IN THE OVEN – PRACTICAL HINTS

Baking

- we recommend using the baking trays which were provided with your cooker;
- it is also possible to bake in cake tins and trays bought elsewhere which should be put on the drying rack; for baking it is better to use black trays which conduct heat better and shorten the baking time;
- shapes and trays with bright or shiny surfaces are not recommended when using the conventional heating method (top and bottom heaters), use of such tins can result in undercooking the base of cakes;
- when using the ultra-fan function it is not necessary to initially heat up the oven chamber, for other types of heating you should warm up the oven chamber before the cake is inserted;
- before the cake is taken out of the oven, check if it is ready using a wooden stick (if the cake is ready the stick should come out dry and clean after being inserted into the cake);
- after switching off the oven it is advisable to leave the cake inside for about 5 min.;
- temperatures for baking with the ultra-fan function are usually around 20 – 30 degrees lower than in normal baking (using top and bottom heaters);
- the baking parameters given in Table are approximate and can be corrected based on your own experience and cooking preferences;
- if information given in recipe books is significantly different from the values included in this instruction manual, please apply the instructions from the manual.

Roasting meat













- cook meat weighing over 1 kg in the oven, but smaller pieces should be cooked on the gas burners.
- use heatproof ovenware for roasting, with handles that are also resistant to high temperatures;
- when roasting on the drying rack or the grate we recommend that you place a baking tray with a small amount of water on the lowest level of the oven;
- it is advisable to turn the meat over at least once during the roasting time and during roasting you should also baste the meat with its juices or with hot salty water – do not pour cold water over the meat.

BAKING IN THE OVEN – PRACTICAL HINTS



































ECO Heating

- ECO Heating an optimised heating function designed to save energy when preparing food.
- You cannot reduce the cooking time by setting a higher temperature; preheating the oven is not recommended.
- Do not change the temperature setting and do not open the oven door during cooking.

Recommended setting for ECO Heating

Type of dish	Oven functions	Temperature °C	Level	Time (min.)
		180 - 200	2 - 3	50 - 70
		180 - 200	2	50 - 70
		190 - 210	2 - 3	45 - 60
		200 - 220	2	90 - 120
		200 - 220	2	90 - 160
		180 - 200	2	80 - 100

BAKING IN THE OVEN – PRACTICAL HINTS

Type of dish	Oven functions	Temperature °C	Level	Time (min.)
		160 - 200	2 - 3	30 - 50
		160 - 170 ¹⁾	3	25 - 40 ²⁾
		155 - 170 ¹⁾	3	25 - 40 ²⁾
		200 - 230 ¹⁾	2 - 3	15 - 25
		210 - 220	2	45 - 60
		160 - 180	2 - 3	45 - 60
		190	2 - 3	60 - 70
		230 - 250	4	14 - 18
		225 - 250	2	120 - 150
		160 - 180	2	120 - 160
		160 - 230	2	90 - 120
		160 - 190	2	90 - 120
		180 - 190	2	70 - 90
		160 - 180	2	45 - 60
		175 - 190	2	60 - 70
		190 - 210	2	40 - 50
		170 - 190	3	40 - 50

The times are apply to dish that is placed into a cold oven. For the preheated oven, the times should be reduced by about 5-10 minutes.











¹⁾Preheat

²⁾Baking smaller items

Note: The figures given in Tables are approximate and can be adapted based on your own experience and cooking preferences.

TEST DISHES. According to standard EN 60350-1.

Baking



Type of dish	Accessory	Level	Type of heating	Temperature (°C)	Baking time ²⁾ (min.)
Small cakes	Baking tray	3		160 - 170 ¹⁾	25 - 40 ²⁾
	Baking tray	3		155 - 170 ¹⁾	25 - 40 ²⁾
	Baking tray	3		155 - 170 ¹⁾	25 - 40 ²⁾
	Baking tray Roasting tray	2 + 4 2 - baking tray or roasting tray 4 - baking tray		155 - 170 ¹⁾	25 - 50 ²⁾
Shortbread	Baking tray	3		150 - 160 ¹⁾	30 - 40 ²⁾
	Baking tray	3		150 - 170 ¹⁾	25 - 35 ²⁾
	Baking tray	3		150 - 170 ¹⁾	25 - 35 ²⁾
	Baking tray Roasting tray	2 + 4 2 - baking tray or roasting tray 4 - baking tray		160 - 175 ¹⁾	25 - 35 ²⁾
Fatless sponge cake	Wire rack + black baking tin diameter 26cm	3		170 - 180 ¹⁾	30 - 45 ²⁾
Apple pie	Wire rack + 2 black baking tins diameter 20cm	2 black baking tins placed after the dia- gonal, back right, front left		180 - 200 ¹⁾	50 - 70 ²⁾

¹⁾Preheat, do not use Rapid preheat function.

²⁾The times are apply to dish that is placed into a cold oven. For the preheated oven, the times should be reduced by about 5-10 minutes.

TEST DISHES. According to standard EN 60350-1.



Grilling

Type of dish	Accessory	Level	Type of heating	Temperature (°C)	Time (min.)
White bread toast	Wire rack	4		250 ¹⁾	1,5 - 2,5
	Wire rack	4		250 ²⁾	2 - 3
Beef burgers	Wire rack + roasting tray (to gather drops)	4 - wire rack 3 - roasting tray		250 ¹⁾	1st side 10 - 15 2nd side 8 - 13

¹⁾Preheat for 5 minutes, do not use Rapid preheat function.

²⁾Preheat for 8 minutes, do not use Rapid preheat function.

Roasting

Type of dish	Accessory	Level	Type of heating	Temperature (°C)	Time (min.)
Whole chicken	Wire rack + roasting tray (to gather drops)	2 - wire rack 1 - roasting tray		180 - 190	70 - 90
	Wire rack + roasting tray (to gather drops)	2 - wire rack 1 - roasting tray		180 - 190	80 - 100

The times are apply to dish that is placed into a cold oven. For the preheated oven, the times should be reduced by about 5-10 minutes.

CLEANING AND MAINTENANCE

By ensuring proper cleaning and maintenance of your cooker you can have a significant influence on the continuing fault-free operation of your appliance.

Before you start cleaning, the cooker must be switched off and you should ensure that all knobs are set to the “Off” position. Do not start cleaning until the cooker has completely cooled.

- The oven should be cleaned after every use. When cleaning the oven the lighting should be switched on to enable you to see the surfaces better.
- The oven chamber should only be washed with warm water and a small amount of washing-up liquid.
- Use a soft, moisture absorbing cloth to clean surfaces.
- **Aqualytic Cleaning function:**
 - pour 50cl of water into a bowl placed in the oven on the first level from the bottom,
 - close the oven door,
 - set the temperature knob to 90°C, and the function knob to the top and bottom heaters position 
 - heat the oven chamber for approximately 30 minutes,
 - open the oven door, wipe the chamber inside with a cloth or sponge and wash using warm water with washing-up liquid.
- After cleaning wipe over chamber dry.

Important!

Do not use any abrasive agents, harsh detergents or abrasive objects for cleaning.

Only use warm water with a small amount of dishwashing liquid to clean the front of the appliance. Do not use washing powders or creams.

- Oven is equipped with easily removable wire shelf supports. To remove them for washing, pull the front catch, then tilt the support and remove from the rear catch.

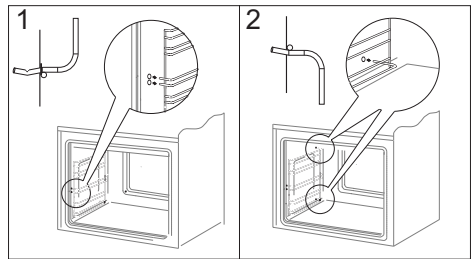

Removing wire shelf supports

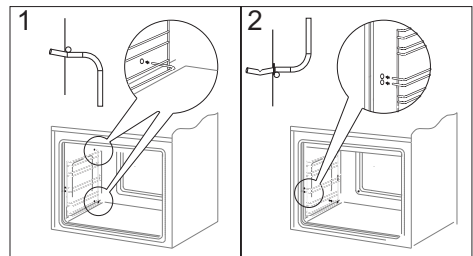

Installing wire shelf supports

CLEANING AND MAINTENANCE

- Oven have stainless steel sliding telescopic runners attached to the wire shelf supports. The telescopic runners should be removed and cleaned together with the wire shelf supports. Before you put the baking tray on the telescopic runners, they should be pulled out (if the oven is hot, pull out the telescopic runners by hooking the back edge of the baking tray on the bumpers in the front part of the telescopic runners) and then insert them together with the tray.

Important!

Do not wash telescopic runners in a dishwasher.

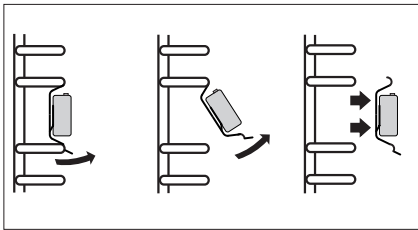

Removing telescopic runners

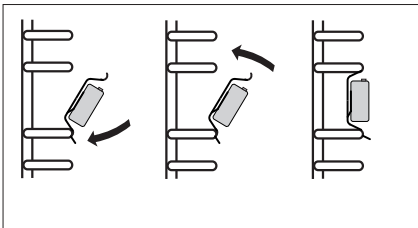

Installing telescopic runners

Replacement of the oven light bulb

In order to avoid the possibility of an electric shock ensure that the appliance is switched off before replacing the bulb.

- Set all control knobs to the position “●”/“0” and disconnect the mains plug,
- unscrew and wash the lamp cover and then wipe it dry.
- unscrew the light bulb from the socket, replace the bulb with a new one – a high temperature bulb (300°C) with the following parameters:
 - voltage 230 V
 - power 25 W
 - thread E14.

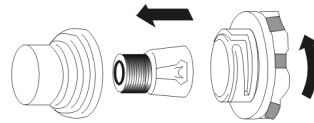

Oven light bulb

- Screw the bulb in, making sure it is properly inserted into the ceramic socket.
- Screw in the lamp cover.

CLEANING AND MAINTENANCE

Door removal

In order to obtain easier access to the oven chamber for cleaning, it is possible to remove the door. To do this, tilt the safety catch part of the hinge upwards (fig. A). Close the door lightly, lift and pull it out towards you. In order to fit the door back on to the cooker, do the inverse. When fitting, ensure that the notch of the hinge is correctly placed on the protrusion of the hinge holder. After the door is fitted to the oven, the safety catch should be carefully lowered down again. If the safety catch is not set it may cause damage to the hinge when closing the door.

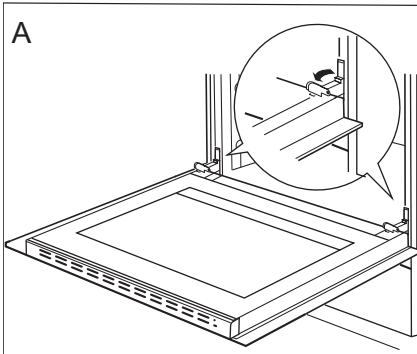

Tilting the hinge safety catches

Removing the inner panel

1. Using a flat screwdriver unhook the upper door slat, prying it gently on the sides (fig. B).
2. Pull the upper door slat loose. (fig. B, C)

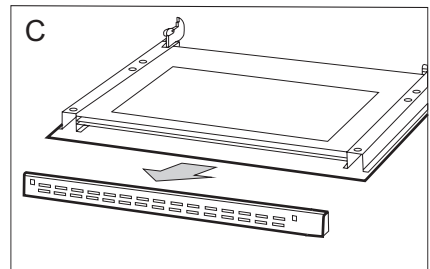
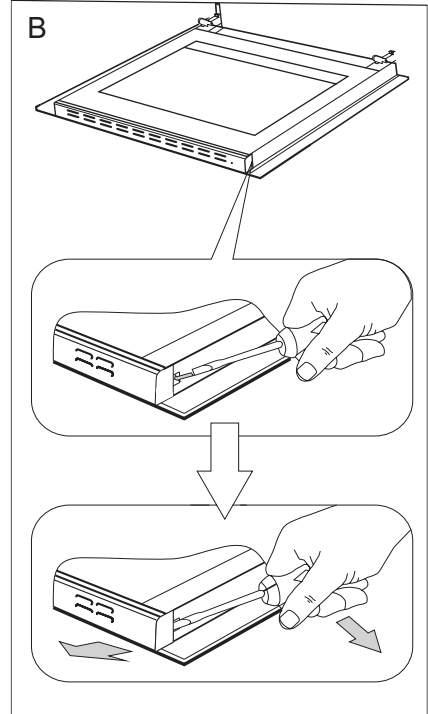

CLEANING AND MAINTENANCE

3. Pull the inner glass panel from its seat (in the lower section of the door). Remove the inner panel (fig. D).

4. Clean the panel with warm water with some cleaning agent added.

Carry out the same in reverse order to reassemble the inner glass panel. Its smooth surface shall be pointed upwards.

Important! Do not force the upper strip in on both sides of the door at the same time. In order to correctly fit the top door strip, first put the left end of the strip on the door and then press the right end in until you hear a “click”. Then press the left end in until you hear a “click”.

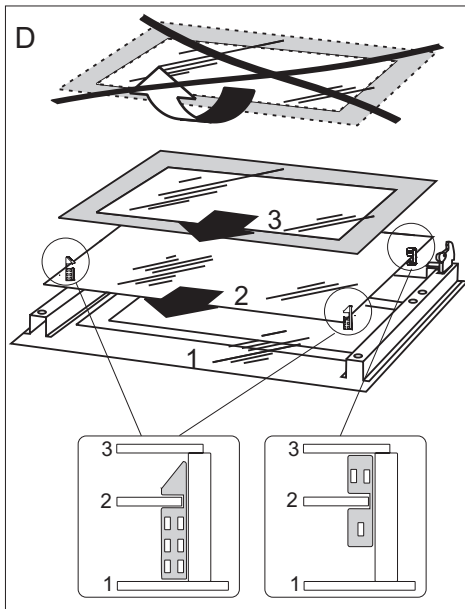

Removal of the internal glass panel

INSTALLATION INSTRUCTIONS

The installation and technical assistance must only be performed by qualified staff. Carefully read the safety instructions in this manual before using the oven. Incorrect installation, maintenance, assistance and use can cause serious damage/injury to persons or objects.

This product must be installed as instructed in this manual and in compliance with National Standards and local regulations in force.

Do not lift or pull the oven from the door handle and do not force or load weights when this is open.

The purchaser is responsible for installation. Assistance provided by the manufacturer due to incorrect installation is excluded from the warranty.

Features of the cabinet

- The kitchen area should be dry and aired and equipped with efficient ventilation. When installing the oven, easy access to all control elements should be ensured.
- The cabinet and its components must be able to withstand temperatures of up to 90 °C without presenting deformities and/or surface defects.
- The cabinet must enable the free passage of the oven connections.
- All household kitchen units must be protected with fire-resistant material in accordance with the standards in force.
- Hoods should be installed according to the manufacturer's instructions.

Inserting the oven in the cabinet

- Make an opening with the dimensions given in the diagram for the oven to be fitted.
- Make sure the mains plug is disconnected and then connect the oven to the mains supply.
- Insert the oven completely into the opening without allowing the four screws in the places shown in the diagram to fall out.
- Ensure the oven is safely installed inside the cabinet. Use screws to fix the oven to the front face of the cabinet.

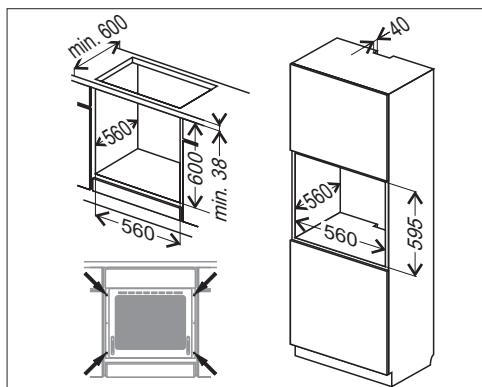

INSTALLATION INSTRUCTIONS

Electrical connection

Warning: This appliance must be earthed.

The appliance must be installed by a competent electrician using a double pole control unit of 16 ampere minimum capacity with 3 mm minimum contact separation at all poles.

We recommend that the appliance is connected by a qualified electrician who is member of the N.C.E.I.C. and who will comply with the I.E.E. and local regulation.

- Access to the main terminal is gained by opening the terminal block cover at the rear of the appliance (use a small flat-bladed screwdriver).
- Connection should be made with 4 mm² twin and earth cable.
- First strip the wires, then push the cable through the cable clamp in the terminal block cover.
- Connect the cable to the terminal block and tighten the cable clamp screw (see diagram).
- Ensure the cable exits through the cable grip clamping on the outer sheath of the cable and fix in place by tightening the fixing screw.
- Ensure all screws are adequately tightened. Do not over tighten as you may risk damaging the screw threads.
- Close the terminal box, ensuring that the cover is engaged on the locking tabs.
- The supply cable must be positioned away from any hot parts of the rear of the appliance. If this cannot be done then another method of protecting the supply cable from the hot parts must be used i.e. Heat resistant sleeving or high temperature cables.

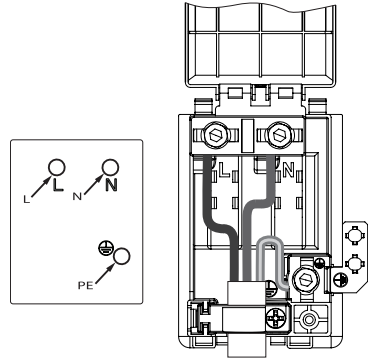

230V 1N~

L - Live (Red or Brown)
N - Neutral (Black or Blue)
PE - Earth (Green/Yellow or sleeving)

Grounding lead must be connected to screw with  symbol.

The power supply cable must have these minimum requirements:

- Type: HO5VV-F (PVC insulated and sheathed flexible cable)
- 3 cores x 4 mm² .

INSTALLATION INSTRUCTIONS

Technical assistance

In case your oven requires technical assistance and/or spare parts, contact the dealer or the authorised technical assistance centre nearest to you.

In this case also it is necessary to state all the appliance data on the rating plate, such as: model, serial number, etc, rating plate placed on the back of the oven and on the last page of the instructions booklet or warranty card.

Problem	Reason	Remedy
1. The appliance does not work	no power	check the fuse, replace if blown
2. Oven lighting does not work.	loose or damaged bulb	Replace the blown bulb (see Cleaning and Maintenance section)
3. Fan does not work	Risk of overheating! Immediately unplug the appliance or switch off the main circuit breaker. Refer the repair to the nearest service centre.	

If the problem is not solved, disconnect the power supply and report the fault.

Important! All repairs must be performed by qualified service technicians.





SPECIFICATIONS

Type / Model	10147.3eETsDbHaScJQaW / ASC420WH/1 10147.3eETsDbHaScJQaS / ASC420WH/1 10147.3eETsDbHaScJQaXSp / ASC420SS/1
Oven dimensions (H/W/D)	595 x 595 x 575 mm
Rated voltage	230 V ~50 Hz
Total power	2800 W
Top heater	900 W
Bottom heater	800 W
Fan oven	1850 W
Grill	1900 W
Full grill	2800 W

The product meets the requirements of European standards EN 60335- 1; EN60335-2-6.

The data on the energy labels of electric ovens is given according to standard EN 60350-1 / IEC 60350-1. These values are defined with a standard workload with the functions active: bottom and top heaters (conventional heating) and fan assisted heating (forced air heating), if these functions are available.

The energy efficiency class was assigned depending on the function available in the product in accordance with the priority below:

Eco fan assisted heating	 ECO
Fan assisted heating	
Fan, bottom heater and top heater	
Bottom heater and top heater (conventional mode)	

During energy consumption test, remove the telescopic runners (if the product is fitted with any).

Manufacturer's Declaration:

The Manufacturer hereby declares that this product complies with the general requirements pursuant to the following European Directives:

- The Low Voltage Directive 2014/35/EC
- Electromagnetic Compatibility Directive 2014/30/EC
- Directive on ErP 2009/125/EC

and therefore the product has been marked with the **CE** symbol and the Declaration of Conformity has been issued to the manufacturer and is available to the competent authorities regulating the market.

PRODUCT FICHE

The information in the product data sheet is given in accordance with the Commission delegated Regulation (EU) No 65/2014 supplementing Directive of the European Parliament and of the Council 2010/30/EU with regard to energy labelling of household ovens and range hoods

Supplier name	Amica S.A.
Model identifier	ASC420WH/1 ASC420WH/1 ASC420SS/1
	10147.3eETsDbHaScJQaW 10147.3eETsDbHaScJQaS 10147.3eETsDbHaScJQaXSp
Energy efficiency index (EEI cavity)	95,1
Energy efficiency class	A
Energy consumption per cycle (EC electric cavity) conventional mode [kWh] fan-forced mode [kWh]	0,99 0,78
Number of cavities	1
Heat source (electricity or gas)	Electric
Cavity volume [l]	65

In order to determine compliance with the eco-design requirements, the measurement methods and calculations of the following standards were applied:

EN 60350-1

PRODUCT INFORMATION

Product information given in accordance with Commission Regulation (EU) No 66/2014 supplementing Directive of the European Parliament and Council Directive 2009/125/EC with regard to eco-design requirements for household ovens, hobs and range hoods

Household ovens

Model identifier	ASC420WH/1 ASC420WH/1 ASC420SS/1
	10147.3eETsDbHaScJQaW 10147.3eETsDbHaScJQaS 10147.3eETsDbHaScJQaXSp
Oven type (electricity or gas)	Electric
Appliance weight [kg]	32,4
Number of cavities	1
Source of heat for each cavity (electricity or gas)	Electric
Volume of each cavity V [l]	65
Energy consumption needed to heat a standard charge in an electric oven cavity during a single cycle in conventional mode for each cavity (final electric energy consumption) EC electric cavity [kWh/cycle]	0,99
Energy consumption needed to heat a standard charge in an electric oven cavity during a single cycle in fan-forced mode for each cavity (final electric energy consumption) EC electric cavity [kWh/cycle]	0,78
Energy efficiency index EEI cavity for each cavity	95,1

Amica S.A.

ul. Mickiewicza 52, 64-510 Wronki, Poland
tel. +48 67 25 46 100, fax +48 67 25 40 320
www.amica.pl
