

Amica

FK3023

Fridge Freezer

Installation, use and maintenance



Contents:

3	Important information
4	Before first use
5	Important safety notes
6	Important notes on use of the fridge
7	Important notes on use of the freezer
8	Information on the LED lighting
8	Important notes on first use and general usage
9	Fridge layout and storage
10	Setting the temperature
11	Defrosting the fridge
12	Defrosting the freezer
13	Care and cleaning
14	Changing the light bulb
15	Troubleshooting
16 - 17	Fridge noise
18	Installation and ventilation
18	Appliance dimensions
19	Electrical information
21	Energy efficiency information

Important

Amica cannot be held responsible for injuries or losses caused by incorrect use or installation of this product. Please note that Amica reserve the right to invalidate the guarantee supplied with this product following incorrect installation or misuse of the appliance.

Under no circumstances should any external covers be removed for servicing or maintenance except by suitably qualified personnel.

Do not use the appliance if the plug, the mains cord or the appliance itself is damaged. If the mains cord is damaged, you must have it replaced by the manufacturer, or an authorised service centre or similarly qualified person in order to avoid a hazard.

Appliance information:

Please enter the details on the appliance rating plate below for reference, to assist Amica Customer Care in the event of a fault with your appliance and to register your appliance for guarantee purposes.

Appliance Model	
Serial Number	

EU Declarations of Conformity:

This appliance meets the requirements of all applicable EU directives with the corresponding harmonised standards which provide for CE marking.



WARNING: Risk of fire/flammable materials

IMPORTANT INFORMATION FOR CORRECT DISPOSAL OF THE PRODUCT IN ACCORDANCE WITH WEEE DIRECTIVE 2012/19/EU.

At the end of its working life, the product must not be disposed of as urban waste. It must be taken to a special local authority differentiated waste collection centre or to a dealer providing this service.

Disposing of a household appliance separately avoids possible negative consequences for the environment and health deriving from inappropriate disposal and enables the constituent materials to be recovered to obtain significant savings in energy and resources. As a reminder of the need to dispose of household appliances separately, the product is marked with a crossed-out wheeled dustbin .

Before first use of the fridge/freezer

You must allow the fridge to settle for at least five hours prior to switching the power on.

It is recommended that you clean the interior of the appliance prior to first use, using a solution of bicarbonate of soda and warm water then thoroughly dry the interior.

The fridge may have an odour to it at first use. This will disappear as the appliance cools.

This appliance has been designed with ease of use in mind but please read the following instructions carefully to ensure you familiarise yourself with the appliance and its operation. This will help you to get the best results and also help to prevent you from being charged for unnecessary service calls.

Important

This appliance is not intended for use by persons (including children) with reduced physical, sensory or mental capabilities, or lack of experience and knowledge, unless they have been given supervision or instruction concerning use of the appliance by a person responsible for their safety.

- Children must not play with the appliance.
- Cleaning and user maintenance must not be made by children without supervision.
- If the appliance is switched off, you should allow five minutes before switching it on again to prevent unnecessary damage to the compressor.
- **WARNING - Keep ventilation openings clear of obstruction.**
- **WARNING - Do not use mechanical devices or other means to accelerate the defrosting process.**
- **WARNING - Do not use electrical appliances inside the food storage compartments of the appliance.**
- **WARNING - Do not damage the refrigerant circuit.**
- **WARNING - Do not store explosive substances such as aerosol cans, with a flammable propellant, within this appliance.**
- Children should be supervised to ensure that they do not play with the appliance.
- This appliance is not intended for use at altitudes exceeding 2000 metres.
- This appliance is a household refrigerator and is intended to be used in domestic environments and similar applications such as staff kitchen areas, farm houses and bed and breakfast type environments. It should not be used in commercial environments.
- If your appliance uses R600a as a refrigerant (this information will

will be provided on the rating plate) you must take care during transportation and installation to prevent the cooling system elements from being damaged. R600a is an environmentally friendly and natural gas, but is explosive. In the event of a leak due to damage to the cooling system, move your fridge away from open flames or heat sources and ventilate the room in which the appliance is located for 5 minutes.

Fridge use

- Never put liquids in the refrigerator uncovered.
- Never put hot foods in the refrigerator. Warm food should be allowed to cool to room temperature before being put into the refrigerator.
- Nothing should rest against the rear wall of the refrigerator, as this will cause frost and possible condensation problems which will be difficult to remove.
- Make sure food is clean and any extra water is wiped away before putting into the fridge.
- Wrap or cover food before putting into the fridge. This will help prevent the loss of moisture, keep food fresh and avoid unpleasant odours.
- Sort foods prior to storing. Any foods to be used soon should be stored at the front of the shelf to prevent deterioration caused by the door being open for prolonged periods.
- Do not overfill the fridge. There should be sufficient space between the foods to allow the cool air to circulate.

- Thawing frozen foods in the fridge compartment will help to keep the temperature low and save energy.
- Never store raw meats above cooked meats or other produce. This will help to prevent juices from raw meat contaminating other foodstuffs. We recommend storing raw meat packages or containers on kitchen roll and changing the roll regularly. This will help to stop raw meat juices running around the appliance.

Freezer use

- The freezer compartments are designed to store only frozen food.
- Never put hot or warm foods in the freezer, allow them to cool fully before putting them into the freezer.
- Follow the instructions on the food packaging for storage of frozen food. If no information is provided, foods should not be stored for more than three months after the purchase date.
- Store food in small packages (ideally less than 2kg). This reduces the freezing time and improves the quality of the food after thawing.
- Wrap food before putting into the freezer. To stop the wrapping sticking together, ensure it is dry.
- Label the food before freezing with information including type of food and dates of storage and expiry.
- Once food is thawed, it must not be refrozen. Only defrost as much food as is required to prevent wastage.

- Bottled or canned drinks should not be stored in the freezer compartments as they could explode.
- The maximum amount of fresh food that can be frozen within a 24 hour period is 8 kg.
- Do not attempt to freeze more than the maximum amount.
- To freeze fresh food more quickly, switch the thermostat to setting 5 a few hours prior to placing the food in the freezer. After the food is frozen, lower the setting.
- Where possible, do not overload your fridge and freezer compartments. This allows for air circulation around the contents and keeping airways etc. as unobstructed as possible will ensure optimum performance.

Important notes on first use and usage

- When you first switch on the appliance, you should ideally run it without any contents for the first 24 hours and not open the appliance doors. If you need to use it straight away, try not to put a large quantity of food inside.
- The appliance will work continuously until it comes down to the correct temperature.
- This appliance features a five minute delay function which, after power has been cut and restored or the appliance turned off and on again, allows five minutes to pass before switching the cooling system on again. This is to prevent unnecessary damage to the compressor.
- The climate class for this appliance is N. This means ambient temperatures should not fall below 16°C or exceed 32°C.

Fridge layout and storage

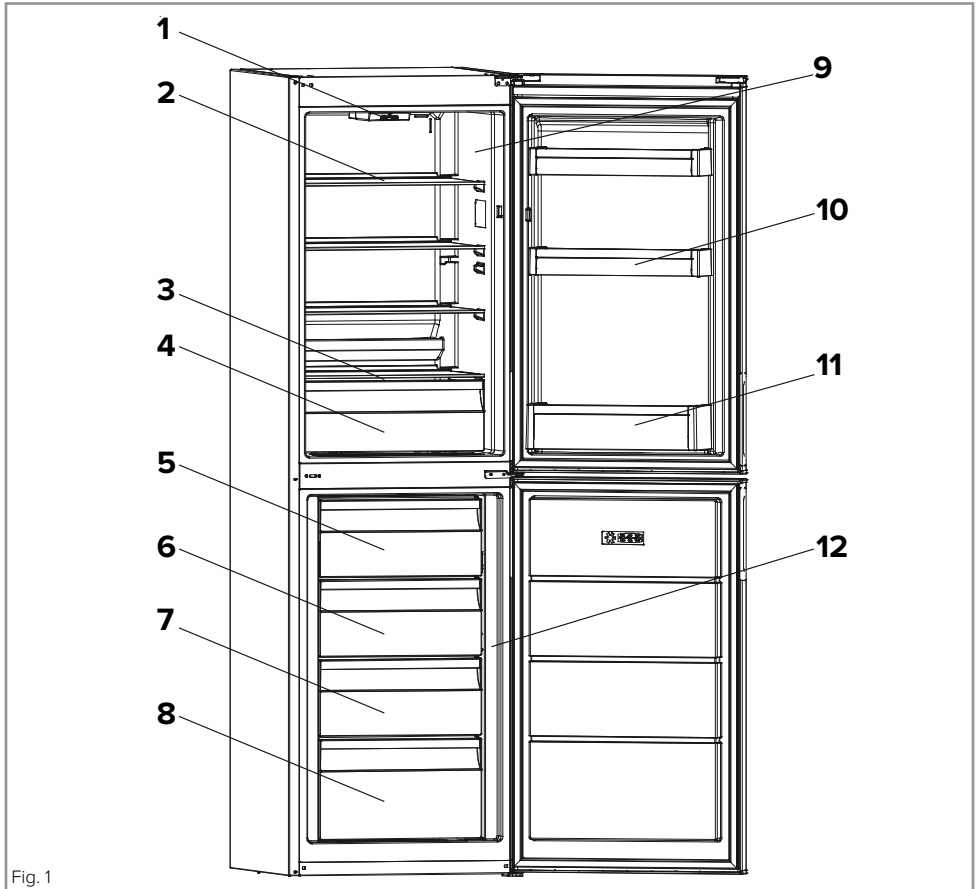

Fig. 1

- 1 - Thermostat dial and light
- 2 - Fridge shelves
- 3 - Crisper cover
- 4 - Crisper
- 5 - Freezer flap
- 6 - Freezer upper basket
- 7 - Freezer middle basket

- 8 - Freezer bottom basket
- 9 - Fridge compartment
- 10 - Door shelves
- 11 - Bottle shelf
- 12 - Freezer compartment

Food types and where to store them within the fridge section:

Vegetables and fruits - Crisper drawer

Red meat - Fridge shelves (lower)

White meat & fish - Fridge shelves (lower)

Cheese - Door shelves (upper)

Butter and margarine - Door shelves (upper)

Bottled milk products and yoghurt - Bottle shelf

Cooked food - Fridge shelves (upper)

Setting the temperature

You must allow the fridge to settle for at least twenty four hours prior to switching the power on.

To adjust the temperature turn the thermostat control knob from left to right to the required level. This ranges from 1 to 5. The temperature becomes colder the higher the number on the control.

When the thermostat is set to • the cooling system is switched off.

We recommend initially setting the temperature control in mid range for the first 24 hours then adjusting the temperature up or down from this point as your personal preference. If your fridge is often relatively empty, set the thermostat to a low number to help prevent straining the system.

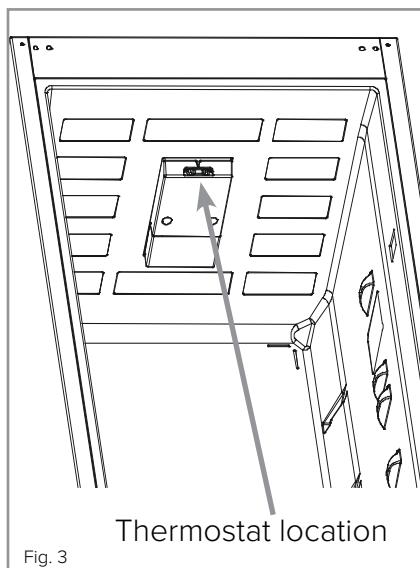

Defrosting the fridge

The fridge should not require defrosting in normal operation. Any water from the back wall of the fridge gathers in a channel at the rear of the appliance, drains through a drain hole and collects in the evaporating tray above the compressor. The evaporating tray (at the rear of the appliance, above the compressor - Fig. 5) and the drain hole (Fig. 4) should be cleaned periodically to prevent issues.

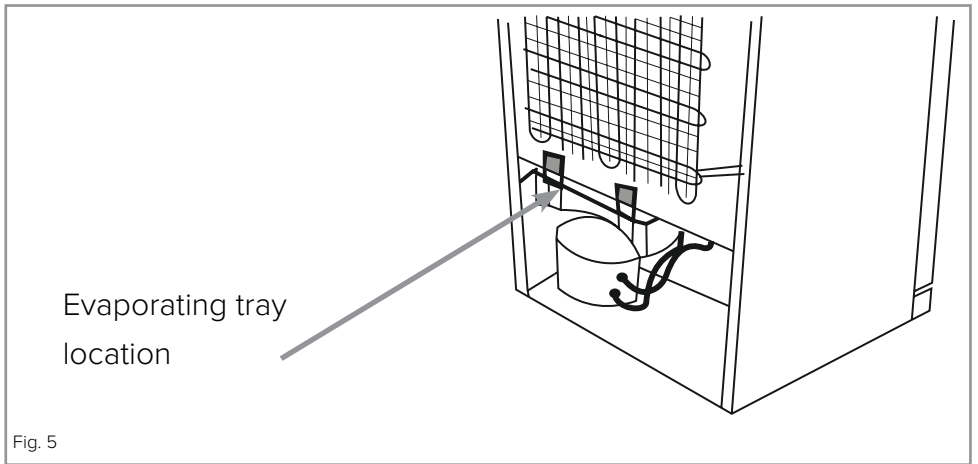
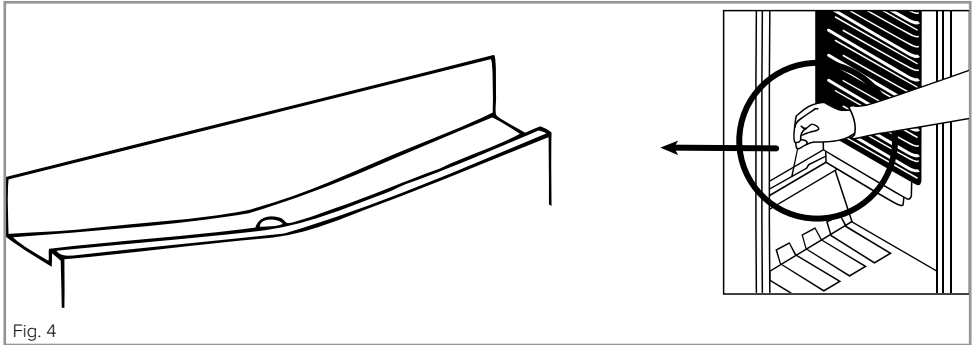

Please note: If you notice water pooling in the fridge, and the evaporating tray is dry, it is likely that the drain hole passage is blocked.

Defrosting the freezer

Do not use heaters or defrosting sprays in this appliance. Always disconnect the appliance from the power source before defrosting.

- Never use any metallic or sharp objects to remove the ice as this could damage the lining.
- The freezer compartment should be defrosted regularly to ensure the most efficient running of the freezer. Once the ice is more than 5mm thick, the freezer should be defrosted.
- First remove the freezer drawers. To speed up the process, place a bowl of warm water in the base of the freezer compartment.
- Once defrosting is complete, dry the inside of the freezer compartment with a sponge or clean cloth thoroughly.
- The freezer interior should be cleaned using a solution of bicarbonate of soda and lukewarm water. Do not use abrasive products or detergents. After washing, rinse and dry thoroughly.
- Clean the drawers separately by hand using soap and water. Do not put them in a dishwasher.
- Once cleaning is complete and everything is dry, reconnect the power.

Care and cleaning

Always disconnect the appliance from the power before ANY cleaning or maintenance.

- Leave spaces between food items wherever possible to allow air to flow between them. Do not allow food items or containers to touch the rear or side walls of the appliance.
- Avoid contact of oily or acidic foods with the rear and side walls. Oils and acids can damage the liner material. If any such foods come into contact with the walls, clean the spot with warm water and bicarbonate of soda.
- The refrigerator and freezer sections should be cleaned using a solution of bicarbonate of soda and lukewarm water. Make sure that no water enters the lamp housing or other electrical components.
- Do not use abrasive products or detergents. After washing, rinse and dry thoroughly.
- Clean the shelves and balconies separately by hand, using soap and water. Do not put them in the dishwasher.
- Keep the door seals clean to avoid damage to them and to help to ensure that they continue to function correctly.
- Once cleaning is complete, then reconnect the power.
- If the appliance is not used for prolonged periods of time, unplug and clean it. The doors should be left slightly open to prevent the formation of mildew or odours.
- Where possible (e.g. freestanding appliances), clean the condenser (black grille on the back of the appliance) with a soft bristle brush at least twice a year.

Changing the light bulb

If the light bulb in your appliance fails, contact Amica Customer Care using the details on page 17. This is because LED lighting should only be replaced by authorised personnel.

Troubleshooting

If you have any problems with your appliance, you should check the troubleshooting prior to calling Amica Customer Care, to prevent unnecessary service calls and potential cost. Contact details for Amica Customer Care are on the rear cover of this manual.

If the appliance is not working, check the following;

- There is power to the appliance.
- The thermostat dial is not set to the off position ‘•’.
- The house fuses are intact and the fuse in the plug has not blown.
- The plug socket is functioning correctly. To check this, plug another electrical appliance in to see if the socket is working.

If the appliance is working, but not very well, check the following;

- The appliance is not overloaded.
- The thermostat is set to an appropriate level. For a fully loaded appliance, a higher setting (e.g 4 or 5) is better.
- The doors are closing properly.
- The cooling system at the rear of the appliance is clean and free of dust, and not touching the rear wall.
- There is enough ventilation at the side and rear (p18).

If there is water in the lower part of the refrigerator compartment, check the following:

- There are no items touching the rear wall of the appliance. If there are, adjust their position so that they no longer touch it.
- Check that there is some resistance when opening the door of the appliance. If it opens at the slightest touch it may mean that the door seal needs to be replaced.

- Check the door seal for any kinks, debris or damage. If you notice any, and are unable to resolve the issue yourself, contact Amica Customer Care so that the seal can be replaced.
- If you notice water pooling in the fridge, and the evaporating tray is dry, it is likely that the drain hole passage is blocked. You can pour warm (not hot) water down the drain channel to help this.

If ice/frost has formed on the back wall of the fridge;

- It is normal for some ice droplets and/or frost to form on the back wall of the fridge. This does not constitute a fault with the appliance.
- Ensure that no items inside the fridge are in contact with the back wall.
- Check that there is some resistance when opening the door of the appliance. If it opens at the slightest touch it may mean that the door seal needs to be replaced.
- Check the door seal for any kinks, debris or damage. If you notice any, and are unable to resolve the issue yourself, contact Amica Customer Care so that the seal can be replaced.

If the appliance is noisy, check the following;

- The appliance is level and stable.
- The side, underside and rear walls are clear, and there is nothing resting on the appliance.
- It is normal to hear the compressor running. This will operate periodically and more so when the appliance doors are opened.
- The appliance may make what seem to be peculiar noises, even when the compressor is not running. Details of the sorts of noise you may hear are on page 17.

Cracking noise, similar to ice cracking - Normal noise that can occur when the appliance is cooling or warming. Due to the expansion and contraction of appliance materials.

Loud click - Normal noise and is usually the thermostat switching the compressor on or off.

Ticking sound - Normal noise that is usually caused by the functions of a valve at the back of the refrigerator.

Motor sound - Normal noise caused by the compressor running, sometimes accompanied by a brief metallic rattle. This sound may be more intense for the first seconds after the compressor starts. If the metallic noise (i.e. metal hitting metal) is constant then it may be that a compressor mount is loose. Contact the Customer Care Department in this instance.

Bubbling noise - Normal noise caused by the movement of the refrigerant within the appliance's pipework.

If none of the aforementioned checks resolves your issue, please contact Amica Customer Care using the contact details below:

A: Amica CCD, The CDA Group Building, Harby Road, Langar, Nottinghamshire, NG13 9HY

T: 01949 862 012 **F:** 01949 862 003

E: customer.care@amica-international.co.uk

W: www.amica-international.co.uk

Installation and ventilation

When installing this product we recommend you seek the help of another individual. This product may have some sharp edges. Please take care and wear adequate PPE when handling.

This appliance must never be installed close to heat sources such as heating elements, radiators, ovens and cookers nor installed in damp places or direct sunlight.

Failure to provide adequate ventilation can lead to increased running costs and premature failure; it may also invalidate the warranty provided with the product.

- The plug should be fully accessible at all times.
- Ensure ventilation openings are kept clear.
- Do not use a multi-plug adaptor in the socket to connect this appliance alongside other appliances.
- Do not tilt the fridge beyond 45°.
- Do not exert excessive pressure on the appliance.
- **Ensure that there is a gap of no less than 10cm above and to the sides of the appliance to allow for ventilation. The clearance between the sides and adjacent furniture must also allow the doors to open fully. Note that a greater side gap will be required if the appliance is to be positioned next to a wall to allow the doors to open fully.**
- **A gap of 7cm should be allowed for ventilation between the rear wall and the back of the appliance. There are plastic guides/ stoppers supplied with the appliance that should be fitted when**

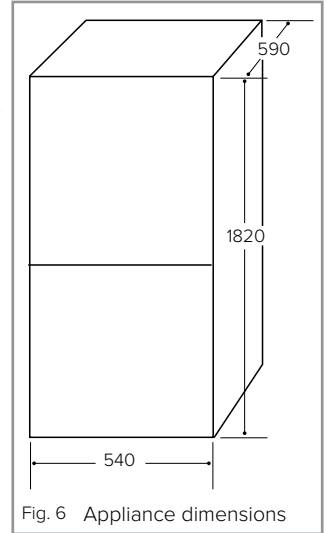

aligning the appliance with a wall. Place the guide into the condenser and turn it by 90° (Fig 7). The guide will then lock into place. Take extreme care not to damage the condenser whilst doing this. These guides will protect the condenser and ensure a minimum air gap.

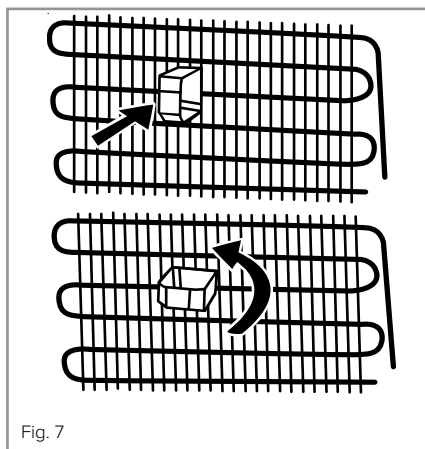

Electrical information

Warning! This appliance must be earthed.

The mains lead of this appliance has been fitted with a specially earthed plug.

Important: Do not use the appliance without the fuse cover in position. Should the fuse need to be replaced, it must be replaced with a 13A fuse, ASTA approved to BS1362.

The plug must be used with a specially earthed socket of 13 amperes. If there is no such socket in your house, please have one installed by an authorised electrician.

If in doubt regarding the electrical connection of this appliance, consult a qualified electrician. Do not shorten the supply cable, the appliance may require removal for servicing.

N.B. Ensure that the plug socket is situated in an easily accessible place.

If the power supply cable or plug is damaged, it must be replaced by an Amica authorised agent. If the plug socket does not match the refrigerator plug, it must be replaced by the manufacturer or an authorised service agent in order to avoid a hazard.

WARNING: When positioning the appliance, ensure the supply cord is not trapped or damaged.

WARNING: Do not locate multiple portable socket outlets or portable power supplies at the rear of the appliance.

WARNING: Do not use plug adapters with this appliance.

Energy Efficiency Information

Attribute	Symbol	Value	Units
Model identification		FK3023	
Category of the household refrigerating appliance		7	
Voltage / Frequency	220 - 240V ~ / 50Hz		
Dimensions (W x D x H cm)	540 x 590 x 1820		
Mass of the appliance	M	58	kg
Energy efficiency class		A+	
Annual energy consumption	A _{Ec}	249	kWh/year
The energy consumption is based on standard test results for 24 hours. Actual energy consumption will depend on how the appliance is used and where it is located.			
Storage volume (fridge)		152	L
Storage volume (freezer)		104	L
Star rating			°C
Defrosting type	Manual		
Climate class		N	
Airborne acoustic noise emissions	pW	42	dB(A)

E & O E. All instructions, dimensions and illustrations are provided for guidance only. Amica reserve the right to change specifications without prior notice.



Amica

For service or queries relating to your product please contact:

The Customer Care Department on **01949 862 012** or email customercare@amica-international.co.uk

For more information please contact:

The Sales Department on **01949 862 010**

Customer Care Department: Amica CCD, The CDA Group Building, Harby Road, Langar, Nottinghamshire, NG13 9HY

T: 01949 862012 **F:** 01949 862003 **E:** customercare@amica-international.co.uk