

# Amica

**AMMB20E1GI**

---

**EN OPERATING INSTRUCTIONS**

# THANK YOU FOR PURCHASING AN AMICA APPLIANCE

EN

DEAR CUSTOMER,

Your Amica appliance is exceptionally easy to use and extremely efficient. Before being packaged and leaving the manufacturer, the appliance was thoroughly checked with regard to safety and functionality.

Before using the appliance, please read these Operating Instructions carefully

Symbols appearing in these instructions have the following meaning:



Important information concerning proper operation of the appliance and your personal safety.



Tips on how to use the appliance.



Risks resulting from improper operation of the appliance. Activities that must be performed by a qualified technician.



Information on how to protect the environment.



This indicates actions that must not be performed by the user.

## CONTENTS

SPECIFICATION	2
PRECAUTIONS	3
SAFETY INSTRUCTIONS FOR USE	4
DISPOSING/SCRAPPING OF USED EQUIPMENT	8
INSTALLING THE PROTECTIVE CIRCUIT	9
COOKWARE	10
SETTING UP YOUR MICROWAVE OVEN	12
TURNTABLE INSTALLATION	12
INSTALLING THE APPLIANCE	13
OPERATION	14
TROUBLESHOOTING	18
CLEANING	18
WARRANTY AND AFTER SALES SERVICE	19
INSTALLATION	20

## SPECIFICATION

Model	AMMB20E1GI
Power supply	230 ~ 50Hz
Operating frequency [MHz]	2450
Noise level [dB(A) re 1pW]	63
Power Consumption [W]	1250
Nominal output power of microwaves [W]	800
Nominal output power of grill [W]	1000
Oven capacity [l]	20
Turntable diameter [mm]	245
External Dimensions (H x W x D) [mm]	383 x 595 x 316
The oven is a built-in appliance	V
Net weight [kg]	13,4



The appliance is designed for household use only.

The manufacturer reserves the right to introduce changes, which do not affect operation of the appliance.



The pictures in this operating instructions are for illustration only. Full list of the appliance accessories may be found in an appropriate section of this operating instructions.

## PRECAUTIONS



TO AVOID POSSIBLE OVER-EXPOSURE TO MICROWAVE ENERGY



Do not attempt to operate the oven with the door open, because it may cause harmful exposure to microwave energy. Do not disable the safety interlocks, or attempt to circumvent them.



Do not place anything between the front surface of the oven and the door or allow dirt or detergent residue to gather on sealing surfaces.



Do not operate the oven if it is damaged. It is particularly important that the oven door is properly closed and that there is no damage to:

1 door (dents, cracks)

2 hinges and locks (broken, cracked or loose)

3 door seals and sealing surfaces



Any adjustments, maintenance or repairs should only be entrusted to the manufacturer's properly qualified service personnel. In particular, the work associated with removing the cover that protects the user against microwave radiation.



Keep the appliance and its power cord away from children under 8 years old.



Microwave oven should not be placed in a cabinet\*



**WARNING:** The appliance and its accessible parts become hot during use. Avoid contact with hot parts. Children under the age of 8, should be kept away from the appliance, unless supervised by an adult person;



Do not clean the appliance with steam



Surfaces of the cabinet may become hot when the oven is operating;

\* applies to oven models that are not built-in appliances

READ CAREFULLY AND KEEP FOR FUTURE REFERENCE



To reduce the risk of fire, injury to people or exposure to excessive microwave energy when using the appliance, please observe the following basic safety rules:



Read the Operating Instructions before using the appliance.



Close supervision is needed to reduce the risk of fire inside the oven chamber.



Use this appliance only for its intended purpose as described in the manual. Do not use corrosive chemicals in the appliance. Oven is specifically designed for heating or cooking food. It is not intended for industrial or laboratory use.



**WARNING:** When the appliance is used in a combined mode, children can use the microwave oven only under adult supervision due to the high temperatures generated;



**WARNING:** Liquids and other foodstuffs may not be heated in sealed containers as the containers could explode;



**WARNING:** This appliance can be used by children aged 8 years and older or by persons with physical, mental or sensory handicaps, or by those who are inexperienced or unfamiliar with the appliance, provided they are supervised or have been instructed how to safely use the appliance and are familiar with risks associated with the use of the appliance. Ensure that children do not play with the appliance. Cleaning and maintenance of the appliance should not be performed by children unless they are 8 years or older and are supervised by a competent person.



Use only cookware that is suitable for use in microwave ovens;



When heating food in plastic or paper containers, pay special attention to the microwave oven as containers may ignite;

 If you see smoke or fire, turn off the appliance or unplug it from power and keep the door closed until the flames are smothered;

Microwave heating of beverages can cause delayed boiling, therefore care should be taken when handling the container;

 Cleaning instructions for door seals and adjacent parts may be found in an appropriate section of this operating instructions.

 The oven must be cleaned regularly. Remove any deposits of food and leftovers

 Neglecting to keep the oven clean can damage the surface, which may adversely affect the durability of the appliance and cause dangerous situations

 Important! If the power cord is damaged, it should be replaced by the manufacturer or specialist repair centre or a qualified person in order to avoid danger.

 Before using the oven, test heat the grill heater (smoke can be given off through ventilation grid):

- switch on the ventilation in the room or open a window,
- set the oven to heat the grill heater only for about 3 minutes without heating food.

 Oven must be placed on flat a surface.

 Turntable and rotating trolley unit should be in the oven during cooking. Carefully put cooked food on the turntable, and handle it carefully to avoid any breakage.

 Improper use of the browning plate may cause cracking of the turntable due to the high temperature.

 Only use bags for cooking in microwave ovens, which are correct size.

 Microwave oven has several in-built circuit breakers to prevent emission of radiation, while the door is open. Do not tamper with these circuit breakers.

## SAFETY INSTRUCTIONS FOR USE

EN



Do not operate the oven when empty. Operating the oven without food or dish with very low water content may result in fire, carbonization, arcing and damage to the internal chamber shell.



Do not cook food directly on the turntable. Excessive local heating of turntable may cause its rupture.



Do not heat baby bottles or baby food in the microwave. Uneven heating may occur and cause physical injury.



Do not use narrow-necked containers such as bottles for syrups.



Do not fry in deep fat in the microwave.



Do not do home canning in a microwave oven because not always the entire contents of pot reaches boiling point.



Do not use microwave oven for commercial purposes. This appliance is intended for use at home or in facilities, such as\*: kitchen for employees; in shops, offices and other working environments, use by the customers of hotels, motels and other residential facilities, in rural residential buildings, in the accommodation facilities\*;



In order to avoid delayed boiling of hot liquids and beverages and the risk of burns, stir the liquid before placing the container in the oven and again in the middle of cooking time. Then leave the container in the oven for a short time and stir again before removing from oven chamber.



Do not forget that there is a dish in the microwave oven to avoid burning due to excessive cooking.



When the appliance is used in a combined mode, children can use the microwave oven only under adult supervision the high temperatures generated;

## SAFETY INSTRUCTIONS FOR USE

2



This appliance is not intended for use by persons (including children) with physical, mental or sensory handicaps, or by persons inexperienced or unfamiliar with the appliance, unless under supervision or in accordance with the instructions as communicated to them by persons responsible for their safety. Children shall not play with the appliance.



Do not overcook dishes



Do not use the oven for storage. Do not store flammable objects inside the microwave oven, such as bread, cookies, paper products, etc. If lightning hits the power line, the oven may switch on automatically.



Remove the wire clamps and metal fixtures from containers / paper or plastic bags before placing them in the oven.



Microwave oven must be grounded. Only connect to a wall socket with the proper protective conductor. See "Installing the protective circuit."



Some products, such as whole eggs (boiled or fresh), water, oil or grease, sealed containers and closed glass jars may explode and therefore should not be heated in the oven.



Operating the microwave oven should be done with adult supervision at all times. Do not allow children to play with the appliance or have access to the controls.



Do not operate the oven when its terminal strip or plug is damaged, it is not working properly, or if it has been damaged or dropped.



Do not cover or block the air vents on the oven.

\* Applicable to microwave ovens with grill

## SAFETY INSTRUCTIONS FOR USE

EN



Do not store or use the oven outdoors.



Do not use the microwave oven near water, near the kitchen sink, in a damp room or near a swimming pool.



Do not immerse the power cord or plug in water.



Keep cord away from heated surfaces.



Do not allow the connection cord hanging over the edge of a table or counter.



The appliance must be used with mounted decorative frame\*



The inner cavity surface is hot after use of the microwave oven.



Regularly check the oven and its power cord for damage. If there is any damage, do not use the oven

## DISPOSING/SCRAPPING OF USED EQUIPMENT



### UNPACKING



During transportation, protective packaging was used to protect the appliance against any damage. After unpacking, please dispose of all elements of packaging in a way that will not cause damage to the environment.

All materials used for packaging the appliance are environmentally friendly; they are 100% recyclable and are marked with the appropriate symbol.

Important! During unpacking, keep the packaging material (polyethylene bags, polystyrene pieces, etc.) out of reach of children.



### DISPOSAL OF THE APPLIANCE



At the end of its useful life, this product must not be disposed of with normal municipal waste. Instead, it should be taken to an electronic waste collection and recycling point. It is indicated by the symbol on the product itself, or on the Operating Instructions or packaging.

The materials used in making of this appliance can be reused, as indicated. By reusing or recycling the materials or parts, you will be playing an important part in protecting our environment.

Information about the relevant disposal points for worn-out electrical goods is available from your local authorities.

\* applicable to built-in appliances



## INSTALLING THE PROTECTIVE CIRCUIT

### DANGER

Danger of electric shock when touched, some internal components may cause serious injury or death. Do not disassemble this appliance.

### WARNING

Electric shock hazard. Improper use of earthing can cause electric shock. Do not insert the plug into the socket before the appliance is properly installed and grounded.

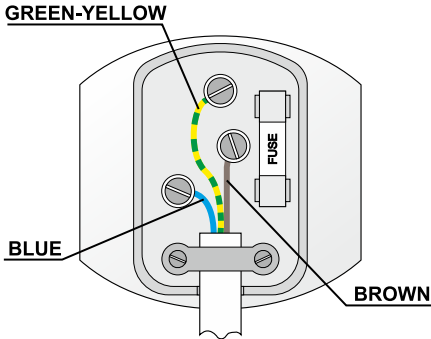

This appliance must be grounded. In the event of a short-circuit, earthing reduces the risk of electric shock. The appliance is equipped with earthing wire with an appropriate plug. The plug should be inserted into a properly installed and grounded outlet.

If you do not completely understand earthing instruction or you are unsure whether the appliance is properly grounded, please contact a qualified

electrician or service technician.

If you must use an extension cord, use only a three-wire extension with an earthing connector. The manufacturer shall not be liable for damage or injury resulting from connecting the microwave oven to a power source without a protective circuit or with a malfunctioning protection circuit.

A short power cord is provided to reduce the risk resulting from becoming entangled or tripping over a long cord.

If you use the extension cord:

- Extension cord must be capable of withstanding nominal current required by the appliance.
- Extension cord must be 3-wire with earthing,
- Extension cord should be so arranged as not to be hung by the table top where it could be pulled by children, or caught inadvertently.

## WARNING



Risk of injury. Tightly closed containers may explode. Closed containers must be opened and plastic bags pierced before cooking.

Materials that can be used and materials to be avoided in the microwave oven.

The use of some non-metallic cookware may not be safe in the microwave oven. If in doubt, you can check the cookware following this procedure.

Checking the cookware:

- 1 Fill the microwave-safe cookware with 1 cup of cold water (250 ml), and do the same with the test cookware.
- 2 Operate the oven with the maximum power for 1 minute.
- 3 Carefully touch the test cookware. If the test cookware is hot, do not use it in the microwave oven.
- 4 Do not exceed 1 minute cooking time.

### Materials that cannot be used in a microwave oven

Type of cookware	Comments
Aluminium tray	May cause an electric arc. Transfer food to microwave-safe cookware.
Cardboard box with metal handle	May cause an electric arc. Transfer food to microwave-safe cookware.
Metal or cookware with metal frame	Metal shields the food from microwave energy. Metal frame can cause an electric arc.
Metal closure - tightened	May cause an electric arc and fire in the oven.
Paper bags	May cause a fire in the oven.
Plastic foam	Plastic foam may melt or contaminate the liquid in it when exposed to high temperatures.
Wood	Wood dries out when it is heated in the microwave oven and can crack or break.

### Materials that can be used in a microwave oven

Type of cookware	Comments
Aluminium foil	Only as shielding. Small and smooth pieces can be used for the coating of thin pieces of meat or poultry, to prevent excessive cooking. Arc discharge may occur if the foil is too close to the oven walls. Film must be at least at a distance of 2.5 cm from the oven walls.
Browning plate	Observe the manufacturer's instructions. The bottom of the browning plate must be at least 5 mm above the turntable. Improper use may cause cracking of the turntable.
Dinner dishes	Suitable for microwave ovens only. Observe the manufacturer's instructions. Do not use cracked or chipped cookware.
Glass jars	Always remove the lid. Use only for heating food to a suitable temperature. Most glass jars are not heat resistant and may explode.
Glassware	Use only heat-resistant glassware in the microwave oven. Make sure that there are no metal frames. Do not use cracked or chipped cookware.

## COOKWARE

Bags for microwave cooking	Observe the manufacturer's instructions. Do not seal with metal clamps.
Paper plates and cups	Cut through to allow the steam to escape. Use only for short cooking / heating. Do not leave the oven unattended while cooking.
Paper towels	Use to cover food to be heated to absorb fat. Use only for short cooking under constant surveillance.
Parchment paper	Use as a cover to prevent splashing or as a container for evaporation.
Plastics	Suitable for microwave ovens only. Should be labelled "for use in microwave ovens." Some plastic containers soften when the content is warmed up. Bags for microwave cooking and sealed plastic bags must be pierced or incised, or vented according to the directions on the package.
Plastic packaging	Suitable for microwave ovens only. Use to cover food during cooking in order to maintain moisture. Do not let plastic packing touch the food.
Thermometers	Suitable for microwave ovens only. (Temperature probes for meat and sugar).
Wax paper	Used as a covering to prevent splashing and to keep moisture.

Cookware material	Microwave	Barbecue grill	Combi Mode
Heat-resistant glass	YES	YES	YES
Regular glass	NO	NO	NO
Heat-resistant ceramics	YES	NO	NO
Microwave-safe plastic utensils	YES	NO	NO
Kitchen paper	YES	NO	NO
Metal container	NO	YES	NO
<b>Metal rack (provided for the oven)*</b>	<b>NO</b>	<b>YES</b>	<b>NO</b>
Aluminium foil and foil containers	NO	YES	NO

\* Available on selected models

# SETTING UP YOUR MICROWAVE OVEN

EN

## Microwave oven accessories

Remove all packaging, both inside and outside the oven, before using the oven. The oven comes with the following accessories:

Turntable	1
Rotating trolley	1
Operating Instructions	1
Grilling rack	1*

- A) Control Panel
- B) System security lock - disconnects power to the oven when the door is opened during operation.
- C) Rotating trolley
- D) Turntable
- E) Door inner protecting shield
- F) Door



## TURNTABLE INSTALLATION

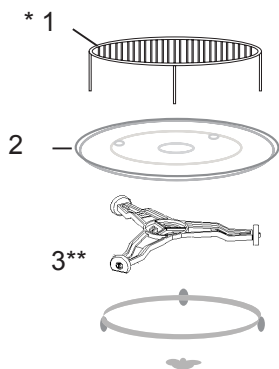

- 1 Never compress or place the turntable upside down.
- 2 When cooking, always use turntable and rotating trolley.
- 3 For cooking or heating always put the food on the turntable.
- 4 If the turntable breaks, please contact the nearest authorized service centre.

Individual fittings:

1. Grilling rack
2. Turntable
3. Rotating trolley

\* Available on selected models **Note:** The grilling rack supplied with the appliance should only be used when the appliance is set to "GRILL". Place the rack on the turntable.

\*\* Trolley is available in two versions, depending on the model. These are not interchangeable.

## INSTALLING THE APPLIANCE

- Remove all packaging materials and components.
- Check the oven for damage such as dents or door misalignment or breakage.
- Remove any protective film from the surface of the cabinet.
- Do not install the oven if it is damaged.



Do not remove the light brown mica cover bolted into the recess in order to shield the microwave magnetron.

### Installing

1. The appliance is designed for household use only.
2. The appliance can be used only after fitting in kitchen furniture.
3. For fitting instructions, please refer to "Installation guide"\*.
4. Microwave oven should be installed in a cabinet with a width of 60 cm and a height of 85 cm from the kitchen floor\*.

Do not remove the legs located in the bottom of the appliance\*.

Blocking the inlet and outlet openings may damage the microwave oven.

Place the oven as far away from radio and television as possible. Operating microwave oven may cause interference to radio and television reception.

2. Insert the oven power plug into a standard household wall socket.

Make sure beforehand whether voltage and frequency are the same as on the oven's rating plate.

**WARNING:** Do not install the oven on the gas hob or other heat producing appliance. In the event of such installation, the oven may be damaged and void the warranty.

**Accessible surfaces  
may become hot  
during operation.**



\* Applicable to built-in appliances

This microwave oven has a modern electronic programmer to adjust the parameters of cooking or reheating.

## 1. Setting current time

Once the microwave oven is plugged into the outlet, the display shows 00:00. Proceed as follows:

1. Press minute digits start to flash
2. Turn to set the hour
3. Press minute digits start to flash
4. Turn to set the minutes
5. Press to store current time setting

Current time must be set so that all oven functions are available. Current time must be stored. If this is not done within 5 minutes, previous time setting will be restored.

## 2. Heating food

**Example: If you want to cook food for 20 minutes using 80% of maximum microwave power, the oven can be set as follows:**

1. Press the screen displays „PI 00“.
2. Press repeatedly or turn , to set microwave power equal to 80%, the display will show „P80“ (the microwave power is marked with the appropriate symbol shown in the table on the next page).
3. Press to confirm.
4. Turn to select the cook time of 20 minutes
5. Press to start heating or to cancel settings

**Note:** Time can be adjusted with different resolution for individual cook time ranges:

0---1 min:	5 seconds
1---5 min:	10 seconds
5---10 min:	30 seconds
10---30 min:	1 minute
30---95 min:	5 minutes

Symbols corresponding to the cooking power:

Microwave power	100%	80%	50%	30%	10%
Symbol shown on the display	P100	P80	P50	P30	P10

## 3. Grilling

**NOTE:** Special rack which is supplied with the oven can only be used during grilling.

1. Press , to select the grill function (the „G“ symbol will be displayed).
2. Press to confirm the selection of the grill function.
3. Turn to set the cook time (ranging from 00:05 to 95:00).
4. Press to start grilling.



**Note:** Once half of the grilling time has elapsed, an acoustic signal will be sounded to indicate that the food should be turned to obtain better cooking result. Open the door, turn the food and press  $\left[ \text{①} + \frac{30}{\text{SEC}} / \text{OK} \right]$  to resume cooking. If this is not done, the appliance will continue to operate until the set cook time has elapsed.

## 4. Combined heating

Combined use of grill and microwave cooking in the appropriate proportions (see C-1 and C-2 table below).

1. Press  $\left[ \text{Ⓜ} \right]$ , the screen displays „G”.
2. Press repeatedly  $\left[ \text{Ⓜ} \right]$  or rotate  $\left[ \text{Ⓢ} \right]$  to set the Combi function indicated on the display as „C-1” or „C-2” (the ratio of microwave to the grill power is presented in the following table).
3. Press  $\left[ \text{①} + \frac{30}{\text{SEC}} / \text{OK} \right]$  to confirm the selection of the Combi function.
4. Turn  $\left[ \text{Ⓢ} \right]$  to set the cook time (ranging from 00:05 to 95:00).
5. Press  $\left[ \text{①} + \frac{30}{\text{SEC}} / \text{OK} \right]$  to start the appliance.

Symbol shown on the display	Microwave power	Grill power
C-1	55%	45%
C-2	36%	64%

## 5. Quick Start

Use this feature to quickly start cooking food. Once the food is placed in the microwave oven press  $\left[ \text{①} + \frac{30}{\text{SEC}} / \text{OK} \right]$  again and again to add cook time and start cooking. Using the Quick Start function you can set a cook time of 30 seconds to 10 minutes. Food is then cooked at maximum power.

## 6. Defrosting by weight

1. Press  $\left[ \text{Ⓜ} \right]$ , button once, the display shows „dEF1” (defrosting by weight).
2. Turn  $\left[ \text{Ⓢ} \right]$  to adjust the weight of food (in the range 100-2000g).
3. Press  $\left[ \text{①} + \frac{30}{\text{SEC}} / \text{OK} \right]$  to start the defrosting process.

## 7. Defrosting by time

1. Press  $\left[ \text{Ⓜ} \right]$ , button twice, the display shows „dEF2” (defrosting by time).
2. Turn  $\left[ \text{Ⓢ} \right]$  to set the cook time (ranging from 00:05 to 95:00).
3. Press  $\left[ \text{①} + \frac{30}{\text{SEC}} / \text{OK} \right]$  to start the defrosting process.

## 8. Multi-stage cooking

Set the cooking programme. Three power levels can be set. Defrosting should be always set first, if it is included in a multi-step programme. The appliance will beep after each programme step has been completed. Auto Menu cannot be used in multi-step cooking.

**Example:** To defrost food for 5 minutes, then cook it for 7 minutes using 80% microwave power, do the following:











1. Press the  $\left[ \text{Ⓜ} \right]$  button twice (the display shows „dEF2.”)
2. Turn  $\left[ \text{Ⓢ} \right]$  to set the defrosting time for 5 minutes.
3. Press  $\left[ \text{Ⓜ} \right]$  once.
4. Turn  $\left[ \text{Ⓢ} \right]$  to set the microwave power of 80% (the display will show „P80”).
5. Press  $\left[ \text{①} + \frac{30}{\text{SEC}} / \text{OK} \right]$  to confirm.

6. Turn  to select the cook time of 7 minutes.
7. Press   $\left| \text{①} + \frac{30}{\text{SEC}} / \text{OK} \right|$  to start the appliance.

## 9. Delayed start

First, set the current time, then the cooking process as described above and then set the desired delayed time.





**Example:** If you want to start cooking food at a given time using a 80% microwave power for 7 minutes, do the following:

1. First set the current time (see pt 1).
  2. Set the cooking programme. Three power levels can be set. Defrosting cannot be set in conjunction with delayed start.
- a) Press  once.
  - b) Turn  to set the microwave power of 80% (the display will show „P80“).
  - c) Press   $\left| \text{①} + \frac{30}{\text{SEC}} / \text{OK} \right|$  to confirm.
  - d) Turn  to select the cook time of 7 minutes. After this, do not press   $\left| \text{①} + \frac{30}{\text{SEC}} / \text{OK} \right|$ , but follow these steps:
    3. Press  hour digits blink.
    4. Turn  to set the hour digits (from 0 to 23).
    5. Press  minute digits blink.
    6. Turn  to set the minute digits (from 0 to 59).
    7. Press   $\left| \text{①} + \frac{30}{\text{SEC}} / \text{OK} \right|$  to start the delayed cooking.

The appliance will beep when cooking starts. The last step will be confirmed by an acoustic signal and then the countdown of the delay time begins. Microwave switches on automatically once the countdown has completed.

## 10. Preset programmes





**Example:** If you want to use the „Auto Menu” to prepare 250 g of fish.

1. Turn  clockwise to select the „A3” function
2. Press   $\left| \text{①} + \frac{30}{\text{SEC}} / \text{OK} \right|$  to confirm the selected preset programme.
3. Turn  to select the weight of 250g.
4. Press   $\left| \text{①} + \frac{30}{\text{SEC}} / \text{OK} \right|$  to start the preset programme.
5. Microwave beeps after cooling is finished.







Menu	Weight	Display
<b>A1</b> Auto Reheat	200	200
	400	400
	600	600
<b>A2</b> Vegetable	200	200
	300	300
	400	400
<b>A3</b> Fish	250	250
	350	350
	450	450
<b>A4</b> Meat	250	250
	350	350
	450	450
<b>A5</b> Pasta	50g (with 450 ml of cold water)	50
	100g (with 800 ml of cold water)	100
<b>A6</b> Potato	200	200
	400	400
	600	600
<b>A7</b> Pizza	200	200
	400	400
<b>A8</b> Soup	200	200
	400	400







## 11. Keeping food warm

1. Press , in standby mode, the display will show „200“.
2. Repeatedly press  or rotate  to select the weight of food (200g, 400g or 600g).
3. Press  +  to start the appliance.

## 12. Child lock

To activate child lock: Press the  for about 3 seconds until the display shows  and a long beep is heard - the child lock is activated. To deactivate child lock: Press the  for about 3 seconds until the display shows  and a long beep is heard - the child lock is deactivated.

## 13. Information functions:

- a) Press  or  during cooking to show the current power level.
- b) Press  when delayed start function is active to show the time setting.
- c) Press  +  to resume cooking after the door is opened and closed.
- d) Press  during cooking to show the current time.

## 14. Cleaning

Make sure the oven has been disconnected from power.

1. Clean the inside of the oven after use with a lightly moistened cloth.
2. Clean accessories in the usual manner with soap and water.
3. If soiled, door frame, gasket and adjacent parts should be thoroughly cleaned with a damp cloth.

## TROUBLESHOOTING

EN

Microwave oven interferes with the TV reception	Television and radio reception may be disrupted when the microwave oven is operating. The same applies to small household appliances such as a blender, vacuum cleaner and electric fan. This is normal.
Dimmed oven lighting.	When cooking with low microwave power, oven light may be dimmer. This is normal.
Condensation forms on the door, hot air comes out through vents.	When cooking, steam can be released from food. Most of the steam escapes through the vents. However some steam can collect in the form of condensation on cooler parts, such as oven door. This is normal.

Fault	Possible cause	How to correct
Oven does not start.	Power cord unplugged or not plugged properly into the socket	Pull the plug and put it back in after 10 seconds.
	Blown fuse or tripped circuit breaker.	Replace the fuse or turn on the circuit breaker (any repairs by Amica service only)
	Problem with the power outlet	Check the outlet by plugging in other appliance.
The oven does not heat.	The door is not closed properly.	Close the door fully.
Turntable makes noise when oven operates	Rotating ring or bottom of the oven dirty.	See "Microwave oven maintenance"

## CLEANING

Before cleaning, make sure the oven is disconnected from the power source.

(a) After use, clean the inside of the microwave oven with a damp cloth.

b) Clean the accessories in the normal way in soapy water.

c) Dirty door frame, seal and adjacent elements should be cleaned gently with a damp cloth. When cleaning the surface of the oven door, use only mild soap or detergent applied with a sponge or soft cloth.

When cleaning glass door, do not use any abrasive cleaners or sharp metal washers, as this may cause scratches on the surface and damage the glass.

In order to clean the inner cavity: put half a lemon in a bowl, add 300 ml of water and turn on the microwave oven at 100% power for 10 minutes.

After cleaning, disconnect the microwave oven from the power and wipe the inside with a soft, dry cloth.

### Manufacturer's Declaration

The manufacturer hereby declares that this product meets the requirements of the following European directives:

- Low Voltage Directive **2006/95/EC**,
- Electromagnetic Compatibility (EMC) Directive **2004/108/EC**,
- *Eco-design Directive* **2009/125/EC**,



and has been marked with the  symbol and issued with a declaration of compliance made available to market regulators.

### Warranty

---

Warranty service as stated on the warranty card

The manufacturer shall not be held liable for any damage caused by improper use of the product.

- ADJUST SCREW A 
- SCREW B 
- TRIM-KIT PLASTIC COVER 

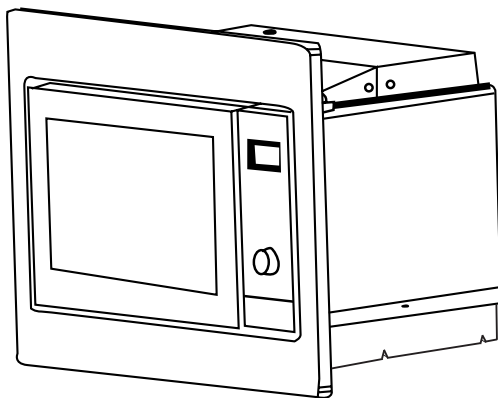

## Electrical connection

The oven is fitted with a plug and must be only connected to a properly installed earthed socket. In accordance with the appropriate regulations, the socket must only be installed and the connecting cable must only be replaced by a qualified electrician. If the plug is no longer accessible following installation and all-pole isolating switch must be present on the installation side with a contact gap of at least 3mm.

## BUILT-IN FURNITURE

The built-in cabinet shall not have a rear wall behind the appliance. Minimum installation height is 85cm. Do not cover ventilation slots and air intake points.

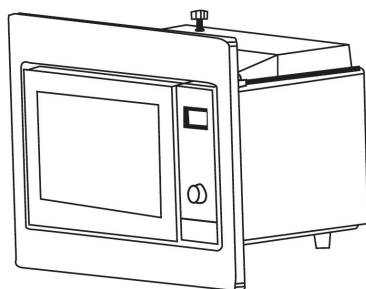
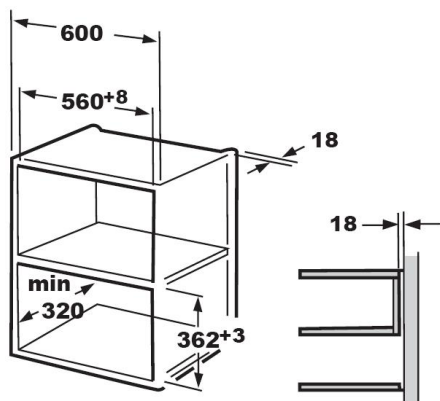

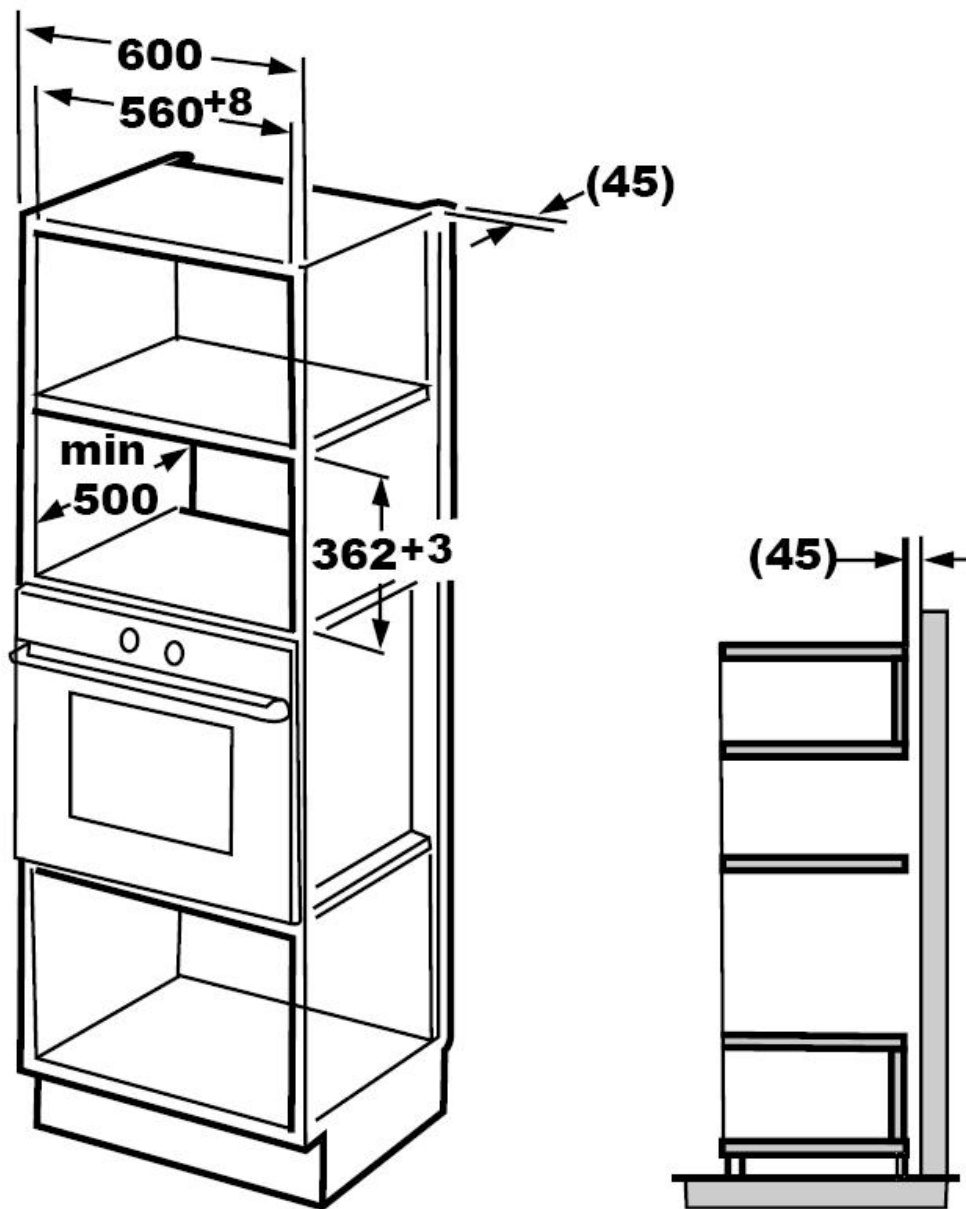

## INSTALL THE OVEN

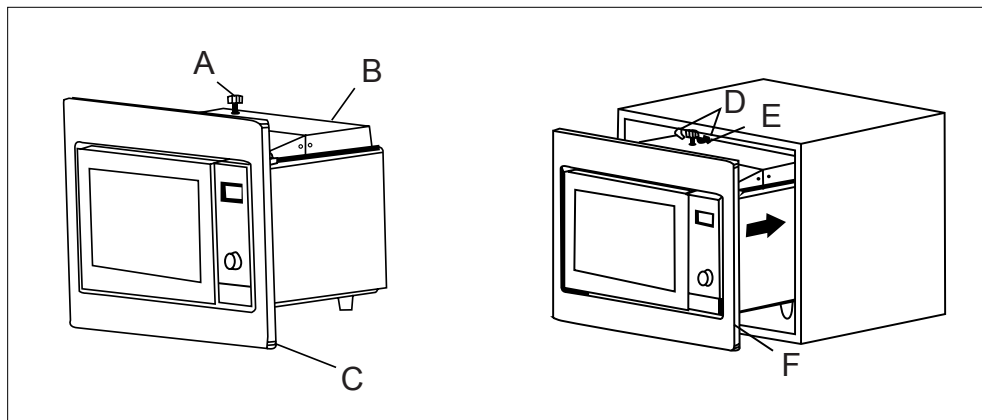

1. Fix ADJUSTSCREW A on the UPPER AIR TUNNEL of the oven, and then install the oven into the cabinet.
  - Adjust the height of ADJUST SCREW A to keep 1mm gap between the ADJUST SCREW A and the top plane of cabinet.
  - Do not trap or kink the power cord.
  - Make sure that the oven is installed in the center of the cabinet.

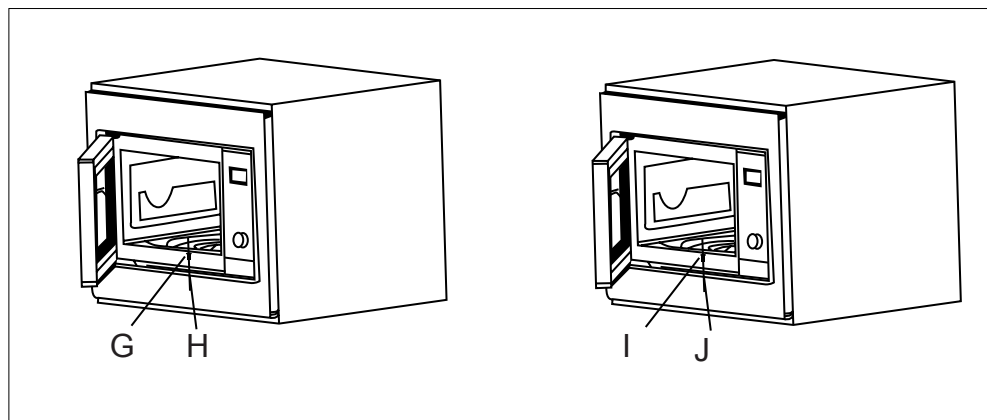

2. Open the door; fix the oven to the cabinet with SCREW B at the INSTALLATION HOLE of TRIM KIT. Then fix the TRIM-KIT PLASTIC COVER to the INSTALLATION HOLE.

- A - ADJUST SCREW A
- B - UPPER AIR TUNNEL
- C - TRIM-KIT
- D - ADJUST HEIGHT
- E - ADJUST SCREW A
- F - TRIM KIT
- G - SCREW B
- H - INSTALLATION HOLE
- I - TRIM-KIT PLASTIC COVER
- J - INSTALLATION HOLE



# Amica

 Service Help Line

For the UK: please call  
**0844 815 8880** (non-geographic number)  
or **01563 557158** (standard rate call)

For Ireland: please call  
**0818 46 46 46** (non-geographic number)  
or **01 842 8222** (standard rate call)