

Amica

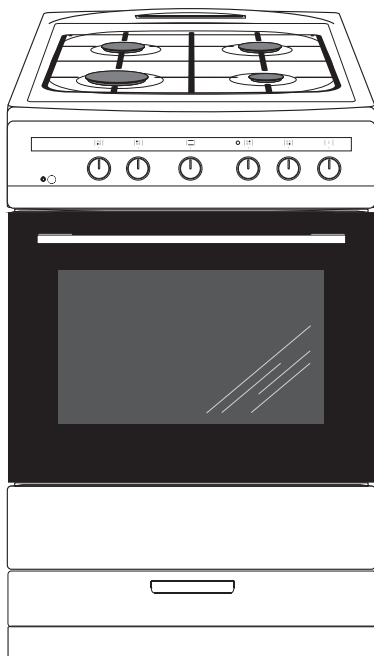

6017GG5.33HZpMsFGQ(W)
6017GG5.33HZpMsFGQ(Xx)

INSTRUCTION MANUAL

GAS COOKER

DEAR CUSTOMER,

The cooker is exceptionally easy to use and extremely efficient. After reading the instruction manual, operating the cooker will be easy.

Before being packaged and leaving the manufacturer, the cooker was thoroughly checked with regard to safety and functionality.

Before using the appliance, please read the instruction manual carefully. By following these instructions carefully you will be able to avoid any problems in using the appliance.

It is important to keep the instruction manual and store it in a safe place so that it can be consulted at any time.

It is necessary to follow the instructions in the manual carefully in order to avoid possible accidents.

Caution!

Do not use the cooker until you have read this instruction manual.

The cooker is intended for household use only.

The manufacturer reserves the right to introduce changes which do not affect the operation of the appliance.

TABLE OF CONTENTS

| | |
|---------------------------------------------------|----|
| Safety instructions | 4 |
| Description of the appliance | 11 |
| Installation | 13 |
| Operation | 18 |
| Cleaning and maintenance | 23 |
| Baking in the oven – practical hints | 28 |
| Technical data | 30 |

SAFETY INSTRUCTIONS

Warning: The appliance and its accessible parts become hot during use. Care should be taken to avoid touching heating elements. Children less than 8 years of age shall be kept away unless continuously supervised.

This appliance can be used by children aged from 8 years and above and persons with reduced physical, sensory or mental capabilities or lack of experience and knowledge if they have been given supervision or instruction concerning use of the appliance in a safe way and understand the hazards involved. Children shall not play with the appliance. Cleaning and user maintenance shall not be made by children without supervision.

Warning: Unattended cooking on a hob with fat or oil can be dangerous and may result in fire.

NEVER try to extinguish a fire with water, but switch off the appliance and then cover flame e.g. with a lid or a fire blanket.

Warning: Danger of fire: do not store items on the cooking surfaces.

SAFETY INSTRUCTIONS

During use the appliance becomes hot. Care should be taken to avoid touching heating elements inside the oven.

Accessible parts may become hot during use. Young children should be kept away.

Warning: Do not use harsh abrasive cleaners or sharp metal scrapers to clean the oven door glass since they can scratch the surface, which may result in shattering of the glass.

Warning: Ensure that the appliance is switched off before replacing the lamp to avoid the possibility of electric shock.

Before opening the cover, cleaning it of any dirt is recommended. The cooker hob surface should be cooled down before closing the cover.

You should not use steam cleaning devices to clean the appliance.

SAFETY INSTRUCTIONS

- Please pay attention to children whilst the cooker is in operation, as children do not know the rules of cooker use. In particular, hot surface burners, the oven chamber, grates, the door pane, and pans containing hot liquids standing on the hob may cause burns to children.
- Mind that electrical connection leads from other home appliances (e.g. of a food mixer) do not touch hot parts of the cooker.
- Do not place flammable material into the drawer whilst using the oven, as it may catch a fire.
- Do not leave the cooker unattended when frying. Oils and fats may catch fire due to overheating.
- At the point of boiling, mind to avoid spills on the burner.
- If the cooker is damaged, it may be used again only after the fault has been fixed by a specialist.
- Do not open the tap on the gas connection or cylinder valve before checking that all burner knobs are closed.
- Do not allow the burners to be soiled or liquids to spill on the burners. If soiled, clean and dry burners immediately after they have cooled down.
- Do not put pans directly onto burners.
- Do not place pans with a weight greater than 10 kg onto the grate over one burner, or pans with a total weight of over 40 kg on the whole grate.
- Do not hit the knobs and burners.
- Do not put objects with a weight greater than 15 kg onto the open oven door.
- Alterations and repairs carried out by an unqualified person are not allowed.
- Do not open the cooker knobs before already having a lighted match or a gas lighter in your hand.
- Do not put out a burner flame by blowing.
- A glass cover may crack when heated. Switch off all the burners before lowering the cover. (Cookers with a glass cover).

SAFETY INSTRUCTIONS

- Do not make your own alterations to the cooker in order to adapt it to a different type of gas, move the cooker to another place or make changes to the power supply. These operations may only be carried out by an authorised electrician or fitter.
- Do not use harsh cleaning agents or sharp metal objects to clean the door as they can scratch the surface, which could then result in the glass cracking.
- Keep young children and people not acquainted with the instruction manual away from the cooker.
- **IN CASE OF ANY SUSPICION OF GAS LEAKAGE YOU MUST NOT:**
light matches, smoke cigarettes, switch electrical receivers (door bell or light switch) on and off, or use other electric and mechanical devices that create electrical or percussive sparks. In such a case, immediately close the cylinder valve or tap cutting off gas supply, air the room, and then call a person authorised to repair the source of the leakage.
- In the event of any incident caused by a technical fault, disconnect the power (applying the above rule) and report the fault to the service centre to be repaired.
- Do not attach any antenna cords (e.g. radio) to the gas supply.
- In a case of gas escaping from leaky piping and catching fire, close gas supply immediately using a cutting-off valve.
- In a case of gas escaping from a leaky cylinder and catching fire: throw a wet blanket over the cylinder to cool it down and turn off the cylinder valve. After it has cooled down, take the cylinder out to an open space. Do not use the damaged cylinder.
- When the cooker is not to be used for several days, close the main valve on the gas piping; when using a gas cylinder, close it after each use.
- Using the appliance for cooking and baking results in the emission of heat and moisture in the room in which it is installed. Make sure that kitchen is well ventilated. Natural ventilation openings or forced mechanical ventilation (exhaust hood) should be available.
- Prolonged intensive use of the appliance may require additional ventilation, for example, opening a window or a more effective ventilation, such as increasing efficiency of mechanical ventilation, if applicable.
- The appliance has been designed only for cooking. Any other use (for example for heating) does not comply with its operating profile and may cause danger.

SAFETY INSTRUCTIONS

GAS & ELECTRICAL CONNECTION

Please refer to installation instructions for the Gas & Electrical Safety Regulations and the Ventilation Requirements.

In your own interest, and that of safety, it is the law that all gas appliances be installed by competent persons, who will ensure that the installation is in accordance with „The Gas Safety (Installation & Use) Regulations 1994”, & the „The Gas Safety (Installation & Use) (Amendment) Regulations 1996”. Failure to comply with these Regulations is a criminal offence. CORGI registered installers undertake to work to satisfactory standards.

Disconnection of gas and electric appliances should always be carried out by competent persons.

Warning: This appliance must be earthed.

VENTILATION

The use of a gas cooking appliance results in the production of heat and moisture in the room in which it is installed. Ensure that the kitchen is well ventilated: keep natural ventilation holes open or install a mechanical ventilation device (mechanical extractor hood). Prolonged intensive use of the appliance may call for additional ventilation, for example, opening of a window, or more effective ventilation, for example increasing the level of mechanical ventilation where present.

MOVING THE COOKER

Do not attempt to move the cooker by pulling on the doors or handles. Open the door and grasp the frame of the cooker, taking care that the door does not shut on your fingers.

Take care to avoid damage to soft or uneven floor coverings when moving the appliance. Some cushioned vinyl floor coverings may not be designed to withstand sliding appliances without marking or damage.

HOW TO SAVE ENERGY



Using energy in a responsible way not only saves money but also helps the environment. So let's save energy! And this is how you can do it:

● **Use proper pans for cooking.**

A saucepan should never be smaller than a burner crown.

Always remember to cover and pans.

● **Ensure burners, the grate the hob are clean.**

Soils can prevent heat transfer – and repeatedly burnt-on spillages can often only be removed by products which cause damage to the environment.

In particular, ensure that flame openings in the rings under caps, and openings of burner nozzles are clean.

● **Do not uncover the pan too often (a watched pot never boils!).**

Do not open the oven door unnecessarily often.

● **Only use the oven when cooking larger dishes.**

Meat of up to 1 kg can be prepared more economically in a pan on the cooker burner.

● **Make use of residual heat from the oven.**

If the cooking time is greater than 40 minutes it is recommended to switch off the oven 10 minutes before the end time.

● **Make sure the oven door is properly closed.**

Heat can leak through spillages on the door seals. Clean up any spillages immediately.

● **Do not install the cooker in the direct vicinity of refrigerators/freezers.**

Otherwise energy consumption increases unnecessarily.

UNPACKING



During transportation, protective packaging was used to protect the appliance against any damage. After unpacking, please dispose of all elements of packaging in a way that will not cause damage to the environment.

All materials used for packaging the appliance are environmentally friendly; they are 100% recyclable and are marked with the appropriate symbol.

Caution! During unpacking, the packaging materials (polythene bags, polystyrene pieces, etc.) should be kept out of reach of children.

DISPOSAL OF THE APPLIANCE



Old appliances should not simply be disposed of with normal household waste, but should be delivered to a collection and recycling centre for electric and electronic equipment. A symbol shown on the product, the instruction manual or the packaging shows that it is suitable for recycling.

Materials used inside the appliance are recyclable and are labelled with information concerning this. By recycling materials or other parts from used devices you are making a significant contribution to the protection of our environment.

Information on appropriate disposal centres for used devices can be provided by your local authority.

DESCRIPTION OF THE APPLIANCE

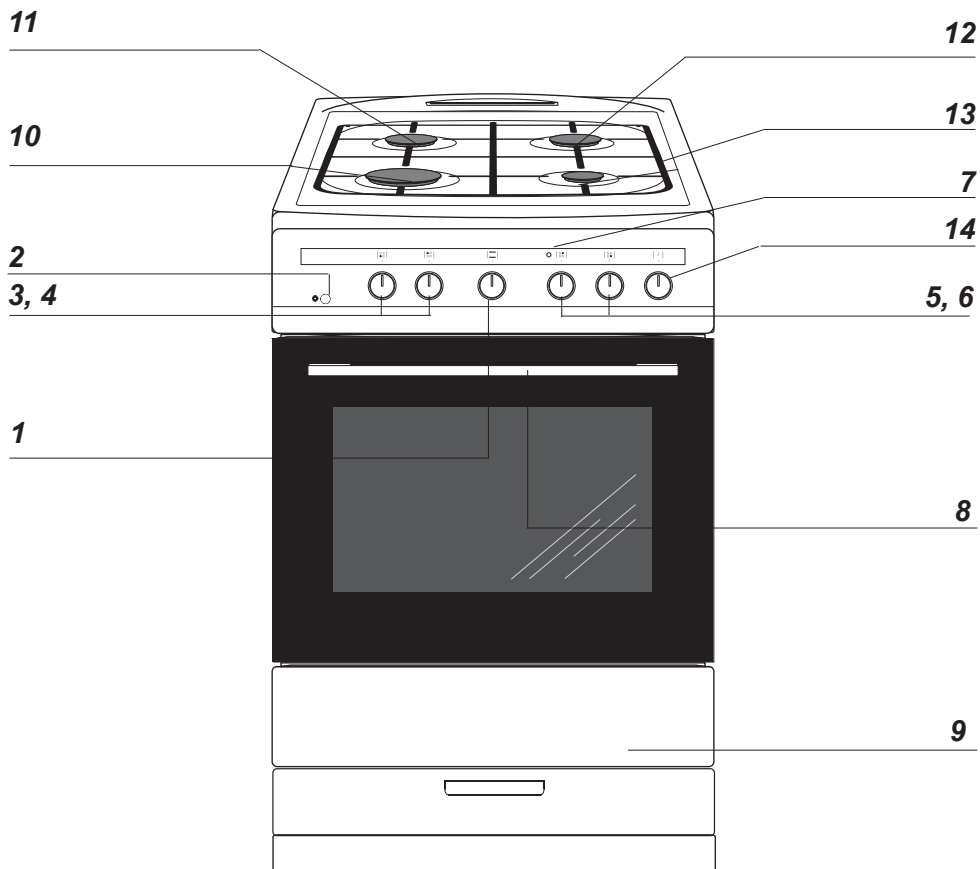

- 1** Temperature control knob
- 2** Push-button oven light
- 3, 4, 5, 6** Gas burner control knobs
- 7** Grill signal light
- 8** Oven door handle
- 9** Drawer
- 10** Large burner
- 11** Medium burner
- 12** Medium burner
- 13** Auxiliary burner
- 14** Timer

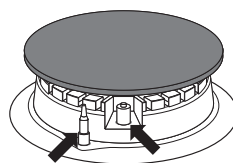

Burner safety valve

Spark ignitor

*optional

SPECIFICATIONS OF THE APPLIANCE

Oven fittings:

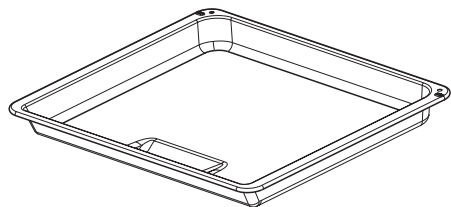

Roasting tray

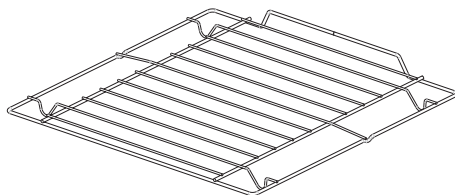

*Grill grate
(drying rack)*

INSTALLATION

Before you start: Please read the instructions. Planning your installation will save you time and effort.

Prior to installation, ensure that the local distribution conditions (nature of the gas and gas pressure) and the adjustment of the appliance are compatible. The adjustment conditions are stated on the data badge.

This appliance is not connected to a combustion evacuation device. It shall be installed and connected in accordance with current installation regulation. Particular attention shall be given to the relevant requirements regarding ventilation.

In your own interest and that of safety, it is the law that all gas appliances be installed and serviced by competent persons. CORGI registered installers undertake to work to satisfactory standards.

Where regulations or standards have been revised since this handbook was printed, always use the latest edition.

In the UK the regulations and standards are as follows:

1. Gas Safety Regulations 1996 (Installation and Use).
2. Building Regulations - Issued by the Department of the Environment.
3. Building Standards (Scotland) (Consolidated) - Issued by the Scottish Development Department.
4. The current I.E.E. Wiring Regulations.
5. Electricity at Work Regulations 1989.
6. BS 6172 Installation of Domestic Gas cooking Appliances.
7. Installation & Servicing Instructions for this appliance.

For installation in countries other than the UK, the appliance must be connected in accordance with all local gas and electrical regulations.

Ventilation Requirements

The room containing the appliance should have an air supply in accordance with BS5440: Part2: 1989:

- All rooms require an openable window, or equivalent, and some rooms will require a permanent vent as well.
- For room volumes up to 5m³ an air vent of 100cm² is required.
- If the room has a door that opens directly to the outside, or the room exceeds 10m³, NO AIR VENT is required.
- For room volumes between 5m³ and 10m³ an air vent of 50cm² is required.
- If there are other fuel burning appliances in the same room, BS 5440: Part 2: 1989 should be consulted to determine the air vent requirements.
- This appliance must not be installed in a bed sitting room of less than 20m³ or in a bathroom or shower room. Windows and permanent vents should therefore not be blocked or removed without first consulting a CORGI gas installer.

Failure to install appliances correctly is dangerous and could lead to prosecution.

Important:

Whilst every care is taken to eliminate burrs and raw edges from this product, please take care when handling - we recommend the use of protective gloves during installation.

Please note that the weight of this appliance is approximately 40kg (unpacked).

Take care if the appliance needs to be lifted during installation - always use an appropriate method of lifting.

INSTALLATION

Clearances

No shelf or overhang or cooker hood should be closer than a minimum of 650mm, but check with cooker hood manufacturer's recommendations.

The cooker must have a side clearance above hob level of 90mm up to a height of 400mm.

Check that there are no projections in the rear wall which will prevent the lid (where fitted) being raised to the vertical position.

This cooker may be fitted flush to base units. However, for models with side opening doors, we recommend a side clearance of 60mm between the cooker and any side wall.

This is a type X appliance regarding installation requirements.

Important:

Ensure that you route all mains cables well clear of any adjacent heat source.

The cooker should stand on a hard, even floor (do not put it on a base).

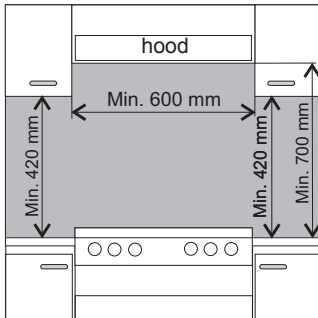

Levelling

Before you start using the cooker it should be leveled, which is particularly important for fat distribution in a frying pan. To this purpose, adjustable feet are accessible after removal of the drawer. The adjustment range is +/- 5 mm.

Mounting the overturning prevention bracket.

The bracket is mounted to prevent overturning of the cooker. When the overturning prevention bracket is installed, a child who climbs on the oven door will not overturn the appliance.

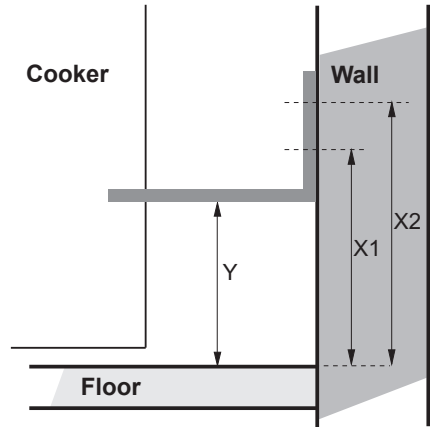

Cooker width W 600 mm, height 850 mm

$X1=Y+30$ mm

$X2=Y+65$ mm

$Y=30$ mm

Cooker width W 600 mm, height 900 mm

$X1=Y+30$ mm

$X2=Y+65$ mm

$Y=80$ mm

X - distance to wall mounting

Y - distance from the floor

INSTALLATION

Connect to the electricity supply

Warning: This appliance must be earthed.

- The cooker is manufactured to work with a one-phase alternating current (220-240V~50 Hz) and is equipped with a 3 x 1,5 mm² connection lead of 1.5 mm length with a plug including a protection contact.
- A connection socket for electricity supply should be equipped with a protection pin and may not be located above the cooker. After the cooker is positioned, it is necessary to make the connection socket accessible to the user.
- Before connecting the cooker to the socket, check if:
 - the fuse and electricity supply are able to withstand the cooker load,
 - the electricity supply is equipped with an efficacious ground system which meets the requirements of current standards and provisions,
 - the plug is within easy reach.

Important:

If the fixed power supply cable is damaged, it should be replaced at the manufacturer or at an authorized servicing outlet, or by a qualified person to avoid danger.

Connect to the gas supply

The inlet to the cooker is 1/2" BSP internal situated at the rear corner.

Fit the bayonet connection. This should be located so as to ensure that the flexible connector hose does not kink.

Use a 900-1125mm length of flexible connector.

Ensure that all pipe work is of the correct rating for both size and temperature.

Flexible connections should comply with BS 669. Parts of the appliance likely to come into contact with a flexible connector have a temperature rise of less than 70°C.

After installation, make sure all connections are gas sound.

Adapting the cooker to another type of gas.

This operation may only be carried out by an appropriately authorised fitter.

If the gas the cooker is to be supplied with differs from the gas provided for the cooker by the manufacturer, burner nozzles must be exchanged and the flame needs to be adjusted.

In order to adapt the cooker to burn a different type of gas, you should:

- exchange nozzles (see tables below),
- adjust the "economical" flame.

Warning:

The cookers provided by the manufacturer have burners which are factory-adapted to use the gas specified on their data plates.

INSTALLATION

Burner of DEFENDI type

| Type of gas | Burner | | | | | |
|-------------------------|--------------------------------------|-----------------------------------|-------------------------------|----------------------------------|-------------------------------|---------------------------------|
| | auxiliary gas injector diameter [mm] | medium gas injector diameter [mm] | | large gas injector diameter [mm] | | oven gas injector diameter [mm] |
| | nominal thermal power 1,00 kW | nominal thermal power 1,40 kW | nominal thermal power 1,75 kW | nominal thermal power 2,40 kW | nominal thermal power 3,00 kW | nominal thermal power 2,80 kW |
| G20 2H 20 mbar | 0,77 | 0,86 | 0,97 | 1,12 | 1,29 | 1,30 |
| G30/31 3+ 28-30/37 mbar | 0,50 | 0,60 | 0,65 | 0,78 | 0,87 | 0,84 |

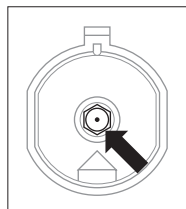

Exchange of a burner nozzle – unscrew the nozzle with special socket spanner No 7 and replace with a new one according to a type of gas (see tables).

In order to perform adjusting operations, take off the knobs. Adjusting elements of the oven burner are accessible after drawing out the oven chamber floor.

The procedure for changing the gas type

| Burner | Flame | Conversion from LPG to natural gas | Conversion from natural gas to LPG |
|--------|-------------|-----------------------------------------------------------------------------------------------------------|-----------------------------------------------------------------------------------------------------------|
| hob | full flame | 1. Replace burner nozzle with the appropriate nozzle according to the table. | 1. Replace burner nozzle with the appropriate nozzle according to the table. |
| | small flame | 2. Gently tighten the adjusting screw and check the flame size. | 2. Gently tighten the adjusting screw and check the flame size. |
| oven | full flame | 1. Replace burner nozzle with the appropriate nozzle according to the table. | 1. Replace burner nozzle with the appropriate nozzle according to the table. |
| | small flame | 2. Gently tighten the adjusting screw and adjust the flame. The temperature in the oven should be 150 °C. | 2. Gently tighten the adjusting screw and adjust the flame. The temperature in the oven should be 150 °C. |

INSTALLATION

Surface burners applied do not require adjustment of primary air. A correct flame has distinct internal cones of blue and green colour. A short, humming flame or long, yellow and smoking one, without clearly outlined cones, shows improper quality of gas in the household piping or a damaged or soiled burner. In order to check a flame, heat a burner for around 10 minutes with a full flame, and next turn the valve knob to the economical flame position. The flame should not go out or jump onto the nozzles.

In cookers with a safety device, a knob with a surface burner safety valve is used, fig. Knobs should be adjusted with the burner switched on and set to the economical flame position, using an adjustment screwdriver of the 2.5 mm size.

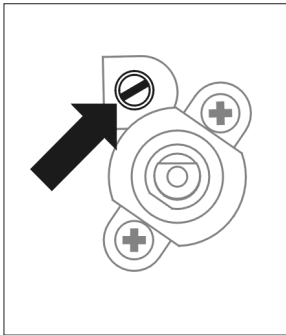

Fig.

A professional installer must adjust the small flame on-site in your home. The adjustment depends on the type of gas and its pressure.

Caution!

After adjustment is completed, place a label indicating the type of gas to which the cooker is now adapted.

OPERATION

Before first use

- remove packaging elements,
- gently (slowly) remove labels from the oven door, trying not to break the glue tape.
- empty the drawer, clean off factory preservatives from the oven chamber,
- take out and wash the oven fittings with warm water and a little washing-up liquid,
- switch on the ventilation in the room or open a window,
- heat the oven (to a temperature of 250°C, for approximately 30 min.), remove any stains and wash carefully.
- when handling the cooker, follow the safety instructions carefully.

The oven chamber should only be washed with warm water and a small amount of washing-up liquid.

Timer

The function of this timer is not only to provide a warning signal about an expiring of time given before, but also have a built-in automatic switch off-function of an oven. These timers have a sign  on a scale.

To put such a timer in action one has turn the ignition knob clockwise until it will be stuck and then set the necessary time within the limits of 0- 120 minutes. If this time is expired, the warning signal occurs and the oven will be switched off.

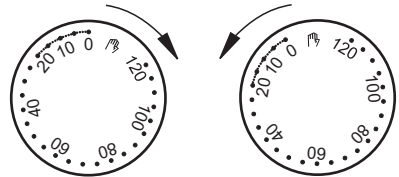

In order to have the oven functioning without any using of an automatic switch off-timer one has to turn the timer into a position . In that position the function of an automatic switch-off of an oven will be not activated.

Important! If this timer with an automatic switch off-function* pointed at "0", the use of an oven is not possible.

OPERATION

How to use surface burners

Choice of cookware

Mind that the diameter of a pan base is always larger than the burner flame crown, and that the pan itself is covered. The recommended pan diameter is around 2.5 to 3 times larger than the burner diameter, that is, for:

- an auxiliary burner – a pan with a diameter of 90 to 150 mm,
- a medium burner – a pan with a diameter of 160 to 220 mm,
- a large burner – a pan with a diameter of 200 to 240 mm, and the pan height should not be greater than its diameter.

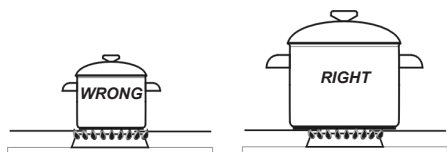

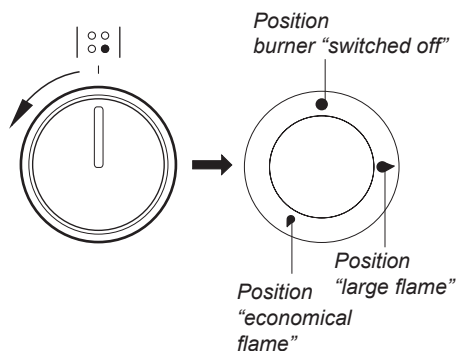

Gas burner control knobs





*optional

Ignition without an ignitor

- light a match,
- press in the knob to the end and turn it left to the “large flame” position ,
- ignite gas with a match,
- set required flame size (e.g. “economical” ) ,
- switch off the burner after finishing cooking, turning the knob right (to the off position ●).

Push-button ignition*



- press the spark ignition push-button marked with ,
- press in the knob to the end and turn it left to the “large flame” position ,
- hold down until gas has lit,
- set the required flame size (e.g. “economical” ) ,
- switch off the burner after finishing cooking, turning the knob right (to the off position ●).

Knob ignition*

- press in the knob to the end and turn it left to the “large flame” position ,
- hold until gas is lit,
- after the flame is lighted release the pressure on the knob and set a required flame size.

OPERATION

Caution!

In cooker models equipped with a surface burner safety valve, hold the knob pressed down to the end when igniting for 10 seconds at the “large flame” position to activate the safety device.

Selection of the appropriate flame

A correctly adjusted burner has a light blue flame with a clearly visible internal cone. Selection of flame size depends on the position of the burner knob which has been set:

- 🔥 large flame
- 🔥 small flame (“economical flame”)
- burner switched off (gas supply is cut off)

Depending on requirements, flame size can be set in a continuous manner.

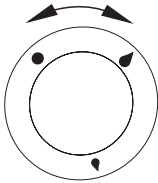

WRONG

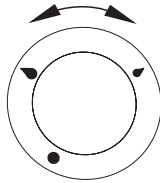

RIGHT

Operation of the burner protection valve

Some models are equipped with an automatic system that cuts off gas supply to a burner when the flame has disappeared.

This system protects the cooker against gas leakage when the flame on a burner goes out e.g. in case of spillage.

The user's intervention is needed to re-ignite the burner.

Caution!

Do not adjust the flame between the off position ● and the large flame position 🔥

OPERATION

Oven functions and operation.

The oven can be heated by oven gas burner or by electric grill*. The oven function is controlled by one knob, which contains a digital scale corresponding to thermoregulator settings.

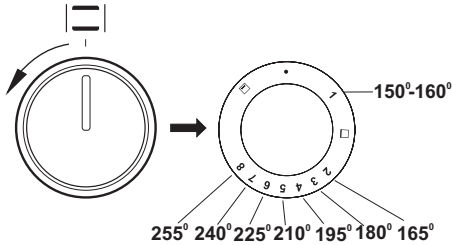

Caution!

In cooker models which do not have a grill, the position  is not present on the knob.

Oven is equipped with gas valve with temperature regulator and anti-outflow protection. To ignite the oven, as in the description below, keep down the pressed knob during about 3 s. This is the time necessary to warm the sensor and to make the protection function. If the flame goes out, repeat ignition operations after a lapse of 3 sec. If the flame does not start burning within 10 sec., repeat the ignition operation after lapse of about 1 min, i.e. after the oven ventilation.

To ignite the oven:

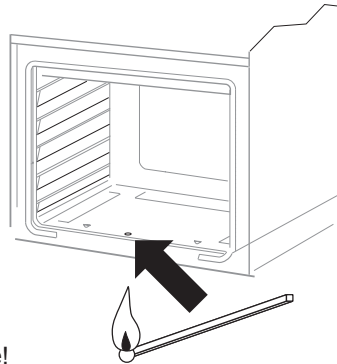

- strike a match,
- press down the knob to the stop and turn left to the position corresponding to the temperature chosen,
- put the match to the ignition opening (see the figure below) and keep the knob pressed down about 3 sec. from the gas ignition moment. If the flame has gone out, repeat the ignition operation after lapse of 3 sec.,



Note!

The temperature control is possible at closed oven door only. Turn the knob right to the stop in order to turn the oven off.

Push-button ignition*

- press the spark ignition push-button marked with ,
- press in the knob to the end and turn it left to the "8 " position,
- hold down until gas has lit,
- set the required position.

Knob ignition

- press in the knob to the end and turn it left to the position 8 ,
- hold until gas is lit,
- after the flame is lighted release the pressure on the knob and set a required position.

OPERATION

Use of the grill

The grilling process operates through infrared rays emitted onto the dish by the incandescent grill heater.

In order to switch on the grill you need to:

- set the oven knob to the position marked with ,
- heat the oven for approximately 5 minutes (with the oven door shut).
- insert a tray with a dish onto the appropriate cooking level, and if you are grilling on the grate insert a tray for dripping on the level immediately below (under the grate).
- the oven door shut.

Caution!

The grill should be used with the oven door shut.

When the grill is in use, accessible parts can become hot.

It is recommended to keep children away from the oven.

The usage of the electric grill is forbidden, when the oven gas burner is on.

CLEANING AND MAINTENANCE

By ensuring proper cleaning and maintenance of your cooker you can have a significant influence on the continuing fault-free operation of your appliance.

Before you start cleaning, the cooker must be switched off and you should ensure that all knobs are set to the “●”/“0” position. Do not start cleaning until the cooker has completely cooled.

▶ Burners, the burner hob grate, the cooker housing

- In the case of soiled burners and grate, these elements must be removed from the cooker and washed with warm water and washing – up products intended for fats and soils. Next, wipe them dry. After the grate has been removed, wash the burner hob carefully and wipe with a dry and soft cloth. In particular, ensure flame openings in rings under caps are clean, see the figure below. Do not use steel wire or drill holes.

Caution!

Burner elements must always be clean. Water particles may hamper gas flow and produce an incorrect burner flame.

Important:

The burner caps and leads must be repositioned correctly so that they sit squarely onto the hob as shown.

correct



incorrect



incorrect



- Wash enamel elements of the cooker with light washing products. When cleaning do not use cleaning agents with a strong abrasive effect, such as scouring powders containing an abrasive, abrasive compounds, abrasive stones, pumice stones, wire brushes and so on.
- Before you start using the cooker with stainless steel hob, its cooking zone first needs to be carefully washed. It is important to remove glue residues from the foils taken off trays during installation, as well as adhesive tape applied during packaging. The hob should be cleaned regularly after each use. Do not allow the hob to get heavily stained, particularly from burnt-on spillages from boiled over liquids. An agent like Stahl-Fix is recommended for the initial wash and, subsequently, for routine washes.

CLEANING AND MAINTENANCE

Oven

- The oven should be cleaned after every use. When cleaning the oven the lighting should be switched on to enable you to see the surfaces better.
- The oven chamber should only be washed with warm water and a small amount of washing-up liquid.
- After cleaning the oven chamber wipe it dry.

Caution!

Do not use cleaning products containing abrasive materials for the cleaning and maintenance of the glass front panel.

Replacement of the oven light bulb

In order to avoid the possibility of an electric shock ensure that the appliance is switched off before replacing the bulb.

- Set all control knobs to the position “●”/“0” and disconnect the mains plug,
- unscrew and wash the lamp cover and then wipe it dry.
- unscrew the light bulb from the socket, replace the bulb with a new one – a high temperature bulb (300°C) with the following parameters:
 - voltage 230 V
 - power 25 W
 - thread E14.

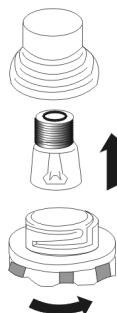

Oven light bulb

- Screw the bulb in, making sure it is properly inserted into the ceramic socket.
- Screw in the lamp cover.

CLEANING AND MAINTENANCE

Door removal

In order to obtain easier access to the oven chamber for cleaning, it is possible to remove the door. To do this, tilt the safety catch part of the hinge upwards (fig. A). Close the door lightly, lift and pull it out towards you. In order to fit the door back on to the cooker, do the inverse. When fitting, ensure that the notch of the hinge is correctly placed on the protrusion of the hinge holder. After the door is fitted to the oven, the safety catch should be carefully lowered down again. If the safety catch is not set it may cause damage to the hinge when closing the door.

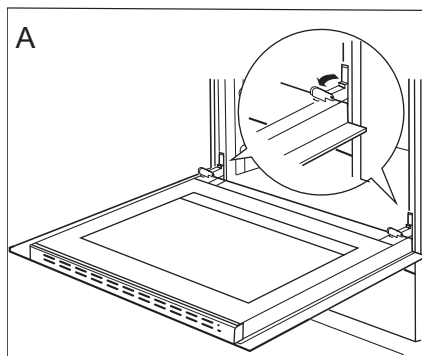

Tilting the hinge safety catches

Removing the inner panel

1. Using a flat screwdriver unhook the upper door slat, prying it gently on the sides (fig. B).
2. Pull the upper door slat loose. (fig. B, C)

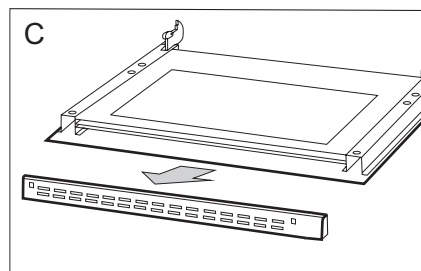
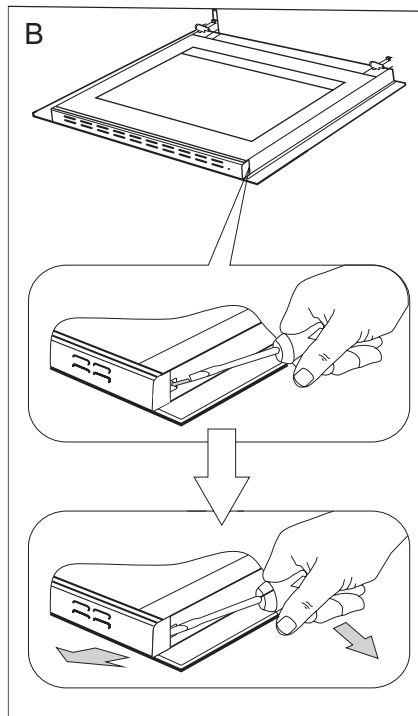

CLEANING AND MAINTENANCE

3. Pull the inner glass panel from its seat (in the lower section of the door). Remove the inner panel (fig. D, D1).
4. Clean the panel with warm water with some cleaning agent added.

Carry out the same in reverse order to reassemble the inner glass panel. Its smooth surface shall be pointed upwards.

Important! Do not force the upper strip in on both sides of the door at the same time. In order to correctly fit the top door strip, first put the left end of the strip on the door and then press the right end in until you hear a “click”. Then press the left end in until you hear a “click”.

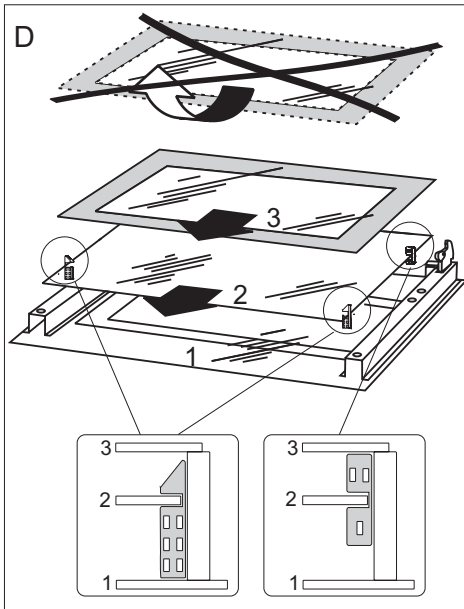

*Removal of the internal glass panel.
3 glass panel.*

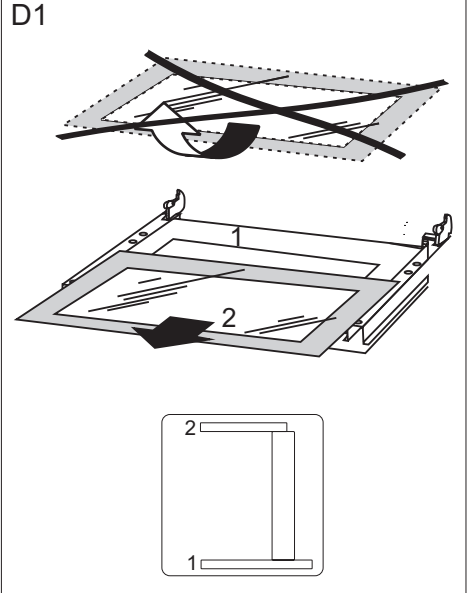

*Removal of the internal glass panel.
2 glass panel.*

Regular inspections

Besides keeping the cooker clean, you should:

- carry out periodic inspections of the control elements and cooking units of the cooker. After the guarantee has expired you should have a technical inspection of the cooker carried out at a service centre at least once every two years,
- fix any operational faults,
- carry out periodical maintenance of the cooking units of the cooker.

Caution!

All repairs and regulatory activities should be carried out by the appropriate service centre or by an appropriately authorised fitter.

OPERATION IN CASE OF EMERGENCY

In the event of an emergency, you should:

- switch off all working units of the cooker
- disconnect the mains plug
- call the service centre
- some minor faults can be fixed by referring to the instructions given in the table below. Before calling the customer support centre or the service centre check the following points that are presented in the table.

| PROBLEM | REASON | ACTION |
|----------------------------------------------|---------------------------------|-----------------------------------------------------------------------------------------------------------------------------|
| 1. A burner does not light | flame openings soiled | close the gas by cutting off valve, close burner knobs, air the room, take out and clean the burner, blow on flame openings |
| 2. A gas ignitor does not light | break in power supply | check the household fuse box; if there is a blown fuse, replace it with a new one |
| | break in gas supply | open the gas supply valve |
| | soiled (greasy) gas ignitor | clean the gas ignitor |
| | knob not pressed in long enough | hold the knob pressed in until a full flame appears around the burner crown |
| 3. The flame goes out when lighting a burner | knob released too quickly | hold the knob down longer at the "large flame" position |
| 4. electrical fittings do not work | break in power supply | check the household fuse box, if there is a blown fuse replace it with a new one |
| 5. the oven lighting does not work | the bulb is loose or damaged | tighten up or replace the blown bulb (see Chapter <i>Cleaning and Maintenance</i>) |

Warning:

All repairs and regulatory activities should be carried out by the appropriate service centre or by an appropriately authorised fitter.

BAKING IN THE OVEN – PRACTICAL HINTS

Baking

- we recommend using the baking trays which were provided with your cooker which should be put on the drying rack;



- before the cake is taken out of the oven, check if it is ready using a wooden stick (if the cake is ready the stick should come out dry and clean after being inserted into the cake);
- after switching off the oven it is advisable to leave the cake inside for about 5 min.;
- the baking parameters given in Tables are approximate and can be corrected based on your own experience and cooking preferences;
- if information given in recipe books is significantly different from the values included in this instruction manual, please apply the instructions from the manual.

| CAKE TYPE | TEMPERATURE [°C] warmed up | TEMPERATURE [°C] | BAKING TIME IN MINUTES | LEVEL FROM THE BOTTOM |
|--------------------|-------------------------------|------------------|---------------------------|-----------------------------|
| Fruit cake | 170 | 160 | 60-70 | 2 |
| Victoria sponge | 170 | 150-160 | 20-40 | 2-3 |
| Sponge layer cake | 170 | 150-160 | 20-30 | 2-3 |
| Buns | 180 | 170 | 30-50 | 3 |
| Teacake | 180 | 180 | 40-50 | 3 |
| Cake (crispy base) | 200 | 180 | 40-60 | 3 |
| Puff pastry | 230-250 | 200-220 | 15-20 | 3 |

BAKING IN THE OVEN – PRACTICAL HINTS

Roasting meat

- cook meat weighing over 1 kg in the oven, but smaller pieces should be cooked on the gas burners.
- use heatproof ovenware for roasting, with handles that are also resistant to high temperatures;
- when roasting on the drying rack or the grate we recommend that you place a baking tray with a small amount of water on the lowest level of the oven;
- it is advisable to turn the meat over at least once during the roasting time and during roasting you should also baste the meat with its juices or with hot salty water – do not pour cold water over the meat.

| TYPE OF MEAT | LEVEL FROM THE BOTTOM | TEMPERATURE [°C] | TIME* IN MINUTES |
|---------------------------------|--------------------------|------------------|---------------------|
| BEEF | | | per 1 cm |
| Roast beef or fillet rare | 3 | 250 | 12-15 |
| oven warmed up juicy ("medium") | 3 | 250 | 15-25 |
| oven warmed up "well done" | 3 | 210-230 | 25-30 |
| oven warmed up Roast joint | 2 | 200-220 | 120-140 |
| PORK | | | |
| Roast joint | 2 | 200-210 | 90-140 |
| Ham | 2 | 200-210 | 60-90 |
| Fillet | 3 | 210-230 | 25-30 |
| VEAL | 2 | 200-210 | 90-120 |
| LAMB | 2 | 200-220 | 100-120 |
| VENISON | 2 | 200-220 | 100-120 |
| POULTRY | | | |
| Chicken | 2 | 220-250 | 50-80 |
| Goose (approx. 2 kg) | 2 | 190-200 | 150-180 |
| FISH | 2 | 210-220 | 40-55 |

* the figures presented in the table refer to a portion of 1 kg, if the portion is larger than that an additional 30 – 40 minutes should be added for each additional kilogram.

TECHNICAL DATA

| | |
|----------------------------------------------|-----------------------------------------------|
| Electrical supply | 220-240V ~50Hz |
| Warning: This cooker must be earthed. | |
| Appliance category | GB II2H3+ |
| Oven: | |
| oven burner | 2,8 kW |
| electric grill | 2,0 kW |
| Usable capacity of the oven | 58 litres |
| Cooker dimensions H/W/D | 90 / 60 / 60 cm |
| Weight | approx. 45 kg |
| Complies with EU regulations | EN-30-1-1, EN 60335-1, EN 60335-2-6 standards |

Certificate of compliance CE

The Manufacturer hereby declares that this product complies with the general requirements pursuant to the following European Directives:

- *The Low Voltage Directive 2006/95/EC,*
- *Electromagnetic Compatibility Directive 2004/108/EC,*
- *Directive on "Appliances Burning Gaseous Fuels" 2009/142/EC,*
- *Directive on ErP 2009/125/EC,*

*and therefore the product has been marked with the **CE** symbol and the **Declaration of Conformity** has been issued to the manufacturer and is available to the competent authorities regulating the market.*

Amica

 Service Help Line

For the UK: please call **0844 815 8880**

For Ireland: please call **0818 46 46 46**
