



ADH 82 LCW

OPERATING INSTRUCTIONS

DRYER

Please carefully read these Operating Instructions before using the appliance!

CONTENTS

Basic Information.....	3
Safety instructions.....	4
Installing the dryer.....	8
Understanding the symbols on clothes labels.....	11
Display and control panel.....	12
Using the appliance.....	15
Table of programmes.....	16
Troubleshooting.....	17
Maintenance and Cleaning.....	19
Specification.....	20
Service and Warranty.....	20
Product fiche.....	21



In accordance with European Directive **2012/19/EC** and Polish legislation regarding used electrical and electronic goods, this appliance is marked with the symbol of the crossed-out waste container.

This marking indicates that the appliance must not be disposed of together with other household waste after it has been used.

The user is obliged to hand it over to waste collection centre collecting used electrical and electronic goods. The collectors, including local collection points, shops and local authority departments provide recycling schemes. Proper handling of used electrical and electronic goods helps avoid environmental and health hazards resulting from the presence of dangerous components and the inappropriate storage and processing of such goods.

BASIC INFORMATION

Dear customer,

From today, DRYING will be easier than ever before. Your Amica DRYER is exceptionally easy to use and extremely efficient. After reading these Operating Instructions, operating the appliance will be easy.

Before being packaged and leaving the manufacturer, the appliance was thoroughly checked with regard to safety and functionality. After these tests some moisture or water may remain in the appliance.

Before using the appliance, please carefully read these Operating Instructions

By following these instructions carefully you will be able to avoid any problems in using the appliance.

It is important to keep these Operating Instructions and store them in a safe place so that they can be consulted at any time.

Follow these instructions carefully in order to avoid possible accidents.



Important!

This dryer is intended for household use only for drying textiles and clothing.

Level the appliance before connecting it to a wall socket.

The manufacturer reserves the right to introduce changes, which do not affect operation of the appliance.

Use

- Carefully read the instructions below before using the appliance.
- Never use the appliance outdoors or anywhere the temperature may fall below freezing.
- The appliance should not be operated by children or anyone who has not read the instructions.

Important! Temperatures below 0°C can damage the appliance!

In the event of the appliance being stored or transported in sub-zero temperatures, it should be left to acclimatise in a temperature above 0°C for 8 hours before being used.

Manufacturer's Declaration

The manufacturer hereby declares that this product meets the requirements of the following European directives:

- Low Voltage Directive **2014/35/EU**,
- Electromagnetic Compatibility (EMC) Directive **2014/30/EU**,

and has been marked with the **CE** symbol and issued with a declaration of compliance made available to market regulators.

NOTES ON SAFETY

- This product is an electrical appliance that is used exclusively for indoor drying fabrics washed in water. Use of safe power supply during the operation!
- The power source must be grounded. The grounding cable must be buried underground and must not be connected to the utilities network, such as water pipe or gas pipe. Grounding and neutral wire and must be distinguished and may not be connected together.
- The power cord must comply with IEC standards and withstand current greater than 10A. If these requirements are not met, you should immediately adapt your domestic electrical system to ensure the safety of your household.
- The appliance can dry up to 8 kg of washed laundry.
- Do not dry chemically cleaned clothes in the dryer
- Do not dry dirty laundry.
- Laundry contaminated with substances such as cooking oil, acetone, alcohol, petrol, kerosene, stain removers, turpentine, wax and wax removers must be washed in warm water with detergent before drying in the dryer.
- Do not attempt to dry the foam rubber (latex foam), bathing caps, waterproof textiles, rubber-lined clothing or pillows fitted with rubber pads in your tumble dryer.
- Fabric softeners or similar products should be as specified in the relevant directions for use.

NOTES ON SAFETY

- Laundry is not heated in the last part of the drying cycle. It is the cooling cycle to make sure the laundry is not damaged and has the right temperature.
- Filters should be cleaned each you use the appliance.
- Always keep the appliance clean.
- The room where the appliance is used must have adequate ventilation. Do not install the appliance in the same room where you use other appliances that produce exhaust fumes and other combustion gases.
- **CAUTION:** Do not turn off the dryer before the drying cycle ends unless the laundry will be quickly removed and hung out in order to dissipate heat.
- Air from the appliance must not be discharged to a chimney used for discharging flue gas from combustion appliances that burn gas or other fuels.
- The appliance must be installed in such a way as to ensure unlimited access to it and the dryer door may be fully opened.
- Keep pets away from the machine.
- Laundry contaminated with oil may ignite spontaneously, especially in the heat generated in a tumble dryer. Heating oil causes oxidation reaction. The oxidation produces additional heat. If the heat cannot dissipate, the laundry can become hot enough that ignition occurs. Stacking fabrics soiled with oil can prevent heat dissipation and create a fire hazard.

NOTES ON SAFETY

- If you cannot avoid tumble drying fabrics soiled with vegetable oil, cooking oil or dirty hair care products, you must first wash dirty laundry in hot water with detergent. In this way you can reduce, but not eliminate the risk.
- Do not overturn the appliance during normal use and maintenance.
- Before drying, make sure there are no foreign objects such as coins, lighters, matches, etc. in clothing pockets.
- This appliance can be used by children aged 8 years and older or persons with physical, mental or sensory handicaps, or those who are inexperienced or unfamiliar with the appliance, provided they are supervised or have been instructed how to safely use the appliance and are familiar with the associated risks. Ensure that children do not play with the appliance. Children should not be allowed to clean or maintain the appliance.

Children less than 3 years of age shall be kept away unless continuously supervised.

- If the power cord is damaged it must be replaced to prevent danger. The power cord can be replaced by a service centre authorized by the manufacturer or by other suitably qualified person.
- This appliance is intended solely for indoor use.
- Make sure any dryer ventilation openings are not blocked by the carpet.

NOTES ON SAFETY

- If the appliance excessively heats up, immediately remove the plug from the wall outlet.
- Do not pull the power cord when removing the plug from the wall outlet.
- Do not insert or remove the plug from the wall outlet with wet hands.
- Do not damage the cord or plug.
- Do not install or disassemble the dryer before you carefully read the operating instructions.
- Do not place the dryer on top of the washing machine without a special kit (You must purchase the stacking kit to install the dryer on top of the washing machine. To avoid the danger hair the dryer must by installed the manufacturer's service technician or other suitably qualified person).
- Do not lean on the open dryer door.
- Do not place objects such as candles or electric stove on the dryer.
- Do not exceed the maximum appliance load.
- Do not use the dryer without the filter base and its cover.
- Do not dry wet laundry that has not been spun.
- Do not expose the dryer to direct sunlight. The appliance is designed for household use only.
- Do not install dryer in rooms with high humidity.
- Unplug the appliance from the wall outlet before any cleaning and maintenance. Do not clean the appliance with water jet.
- Do not dry laundry contaminated with flammable substances, such as oil or alcohol. This could result in an explosion.

INSTALL THE DRYER

I. Position and level the appliance



- For convenience, it is recommended to place the appliance near a washing machine.
- Do not place the appliance on a carpet!
- The dryer must be installed in a clean place, where dirt does not accumulate. There must be free air circulation around the appliance. Do not block the front air inlet or air intake grilles at the back of the appliance.
- The floor surface should not be either concave or sloping!
- Pay attention to the shape of the floor surface, and make sure the entire appliance weight rests on its legs (not its body)!

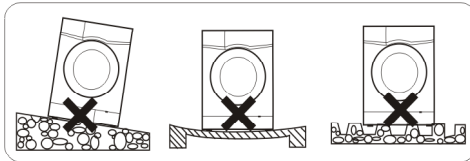

- Place the appliance on a solid, even surface.
- Level the machine by adjusting the legs (1)



After positioning and levelling the appliance, check that it is stable by pressing down each corner and ensuring it does not move!

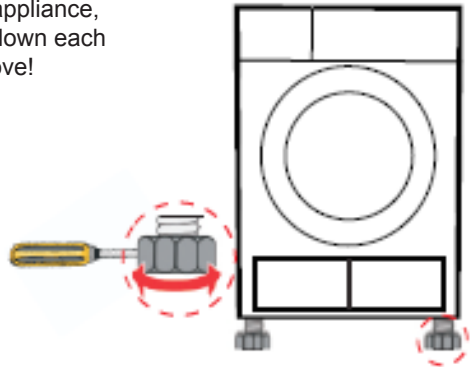

INSTALL THE DRYER

II. Water drain (option)

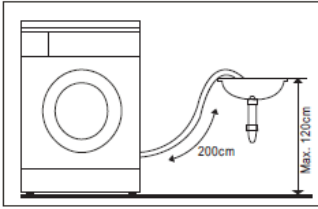

Normally condensed water drains into the container in the upper left corner of the dryer. Optionally, you can use the drain hose in the accessory bag and connect it to the dryer. Connect the hose as shown here.

III. Connect to power supply

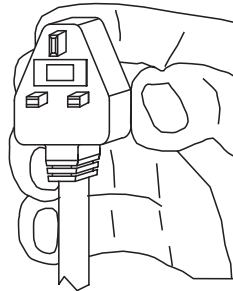
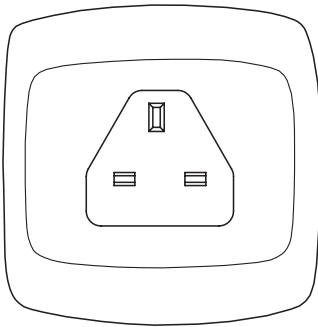











- The appliance's mains connection (electrical wall socket) should be in a visible and accessible place!
- Only plug the appliance into a properly installed socket with an earth pin!
- Do not connect the appliance through any extension cord or an adapter!
- In the event of the power cord being damaged, it must be replaced by an authorised technician.
- The electrical system to which the appliance is to be connected must be protected with a 10 A fuse.

INSTALL THE DRYER













IV. Tips

1. Spin the laundry in the washing machine before tumble drying. The high spin speed can reduce the drying time and save energy.
2. To make sure the drying effects are uniform, sort the laundry by fabric type and drying program.
3. Before the drying close the locks, hooks and buttons, etc.
4. Do not over-dry clothes, as they can easily crease or shrink.
5. Do not dry articles such as raincoats, bike covers or similar flexible materials containing rubber parts.
6. The door can only be opened when the programme completes. This prevents the user from being scalded by hot steam or overheated air.
7. To avoid extended drying cycles and increased energy consumption, clean the appliance filters after each use. Remember to empty the container with water discharged during drying.
8. Use only the dedicated programme to dry woollen garments.
9. Recommended load depending on the kind of laundry to be dried.

Coats (approx. 800 g) 	Jackets (about 800g cotton) 	Jeans (approx. 800 g) 	Quilts (about 900g cotton) 
Sheets (about 600g cotton) 	Working clothes (upper and lower) (about 1120g cotton) 	Pyjamas (approx. 200g) 	Shirts (about 300g cotton) 
T-shirts (about 180g cotton) 	Briefs, panties (about 70g cotton) 	Socks (about 30g fiber mix) 	

UNDERSTANDING THE SYMBOLS ON CLOTHES LABELS

Before drying pay attention to the symbols on the apparel label. Failure to follow the symbol instructions may damage or destroy clothes to be dried. The symbols are explained in the following table:

Dry 	Tumble dry 	Do not tumble dry 	Do not dry 
Line dry/hang to dry 	Drip dry 	Dry flat 	Dry in the shade 
Dry clean 	Do not dry clean 	Dry clean normal cycle with any solvent 	Dry clean normal cycle petroleum solvent only 

Dryer description

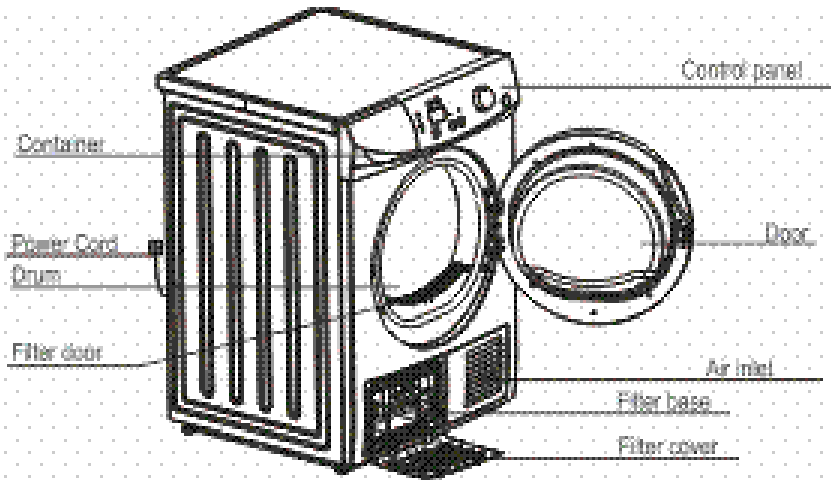

DISPLAY AND CONTROL PANEL

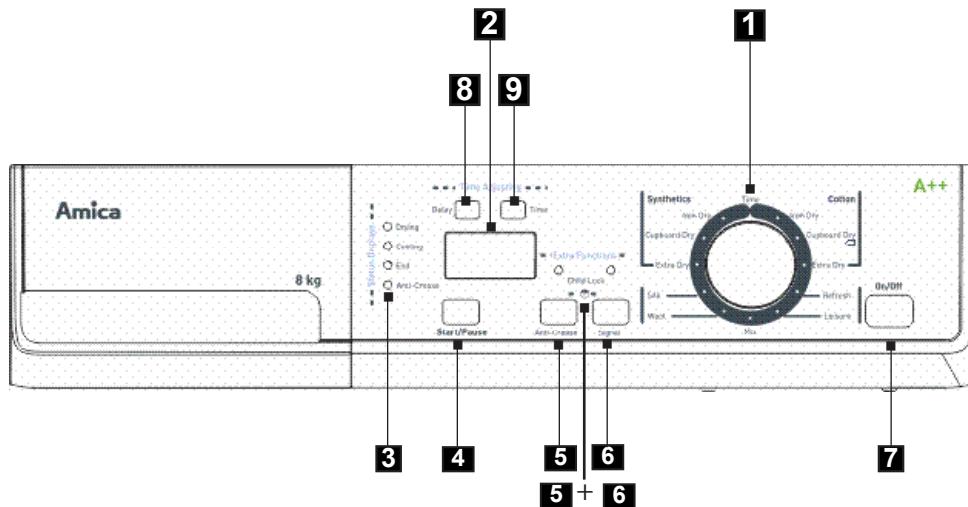

1. Programme selector dial
2. Display
3. Indicators of progress of the program
4. **Start/Pause** button
5. **Anti-Crease** button
6. **Signal** button
7. **On/Off** button
8. **Delay** button
9. **Time** button
- 5 + 6. **Child Lock**

DISPLAY AND CONTROL PANEL

1. Programme selector dial

Choose the appropriate drying programme as required, depending on the type and amount of laundry loaded, which ensures better results and more effective drying. Once the drying programme is started, turning the programme selector knob to another position is possible, however it does not change the previously selected programme.

2. Display

The display shows the remaining time / delay time / error message, soiled filter indicator (caution), water tank full indicator (caution), Child Lock indicator.

- Only light (DELAY / REMAIN) relevant to the phase that is currently being carried out will remain display during the drying process.
- When the drying procedure begins, REMAIN will display the remaining time, that is, the drying procedure will finished in [x:xx] time.
- The display “- ”means programme in “standby” status, you can press any buttons or open the door to awaken programme.

3. Indicators of progress of the program

The four LED lights indicate the status of the drying programme.

4. START/PAUSE button

Press **Start/Pause** to start or pause a programme.

When this button is pressed, this machine is switched between start and pause.

5. Anti-Crease button

Once the programme has ended, the Anti-crease function operates for 10 minutes (default) or 120 minutes (when selected). This function will give more care to protect sensitive textiles from being creased.

6. Signal button

Set up the buzzer on or off. In general condition, the buzzer is off. Please touch it if needed. When the buzzer on:

- (1) The dryer will give the leading sound if press the extra function buttons and knob.
- (2) When the drying programme is done,the buzzer will also remind the user.

7. On/Off button

On/Off button has the on and off function. When this button is pressed, this machine is switched between on and off.

DISPLAY AND CONTROL PANEL

8. Delay button

This function is used drying process to delay. It's possible to get 1-24 hour by prssing this key continuously.

9. Time button

This function is used to adjusted the time of drying. 10-120 minutes by pressing this key continuously.

5 + 6. Child Lock

This function prevents children from changing settings or interrupting appliance operation. Pres and hold **Signal** and **Anti-Crease** button for 3 seconds to activate the Child Lock during a drying cycle. When child lock function is set, the display will show [] icon and only [On/Off] button can be used. To disable Child Lock, press and hold Signal and Anti-Crease buttons for 3 seconds.

Important! If the Child Lock function is activated, the display will show the [] symbol.

Important! When you turn off or unplug the dryer or the drying cycle ends, the Child Lock function will deactivate.

USING THE APPLIANCE

I. Select Programme

1. Press [On / Off]. When the LED display lights up turn the programme selection dial and select the desired programme
2. Select the additional option [Delay], [Time], [Signal] or [Anti-Crease] — if the programme allows you to select additional options.
3. Press the [Start/ Pause] button.

II. Set Delay Start

The delayed start function may be used when, for example, taking advantage of discounted electricity tariffs.

Procedure:

1. Close the appliance door.
2. Set the programme selector knob to the desired programme (see the table further on).
3. Select additional functions or drying cycle parameters as required.
4. Press the Delay Start button.
5. Select time ranging from 1 to 24 hours. The display will show the setting from 1H to 24H.
6. Press the [Start/ Pause] button. The appliance will be set in delay mode. Drying cycle will commence immediately after the delay time has elapsed.

Note: If you set delay start, the display will show the time remaining to start the drying program.

III. End of drying cycle

1. Once the programme has completed, the drum stops rotating and the display shows "0:00". The last programme phase indicator will flash. If you do not remove clothes from the dryer with a specified time, the appliance will start the [Anti-Crease] programme. Press [On/Off] and remove the plug from the wall outlet.
2. If the appliance suddenly stops during the drying programme and displays an error message, follow the information in the "Troubleshooting" section.

IV. Cancel or modify programme

Press the On/Off button to interrupt the programme. Then press on/off button again to turn on the appliance and select the desired drying programme.

TABLE OF PROGRAMMES

	Programme name	Weight (Max) kg	Additional functions available			Recommendations	Time [H:min]	Energy consumption [kWh]
			Delay	Time	Anti-Crease			
Cotton	Extra	8	1-24H	x	y	For cottons and coloureds made of cotton or linen.	03:10	2.1
	Standard		1-24H	x	y		02:58	1.9
	Iron		1-24H	x	y		02:10	1.5
Synthetics	Extra	3.5	1-24H	x	y	To dry thick or multi-layered synthetic fabrics. Drying level: extra dry.	01:10	0.7
	Standard			x	y	To dry thin synthetic fabrics which are not ironed, such as easy care shirts, table linen, baby clothes, socks. Drying level: cupboard dry.	01:00	0.6
	Iron			x	y	To dry thin synthetic fabrics which are also to be ironed, such as knitwear, shirts. Drying level: applicable to iron.	00:40	0.5
Special	Silk	1.0	1-24H	x	y	To dry silk using warm air and gentle movement	00:45	0.35
	Leisure	8.0	1-24H	x	y	For leisure clothing such as jeans, sweatshirts, etc. of different material thicknesses (e.g. at the neck, cuffs and seams).	03:20	2.2
	Refresh	1.0	1-24H	x	x	For refreshing or gently cleaning textiles with commercially available dry cleaning products.	00:20	0.15
	Wool		1-24H	x	x	For a fluffy and fresh wool clothing (Can not be used for drying of wool clothing). After the procedure, Please take out the clothing at once, let it dry in the air.	00:08	0.11
	Mix	3.5	1-24H	x	y	If you can not determine what the clothing's material is, please choose Mix.	01:30	1.2
Time	Time	-	1-24H	y	y	The dryer shall continue running from 10 to 120 minutes.	00:10	-

Note: The above programme is only recommended for use, the user can according to personal habits to choose the right programme. Thick or multi-layered fabrics, e.g. bedlinen, jeans, jackets etc, are not easy to dry. You'd better choose Cotton Extra programme.

TROUBLESHOOTING

Problem	Probable cause/Solution
No information on the display	<ul style="list-style-type: none">- Make sure the plug is properly inserted into the wall outlet.- Check the main power supply.
The dryer does not start	<ul style="list-style-type: none">- Check if the Start / Pause button is pressed.- Make sure the door is properly closed.
The door opens spontaneously	<ul style="list-style-type: none">- Push the door in until it clicks shut.- Make sure the dryer is not overloaded.
The laundry is not sufficiently dry or drying time is too long	<ul style="list-style-type: none">- Clean the top and bottom filter.- Select the appropriate programme.- Do not block the air intake.

Note:

If you can not correct the problem yourself, ask for assistance:

1. Press [On / Off].
2. Unplug the appliance and call service.

TROUBLESHOOTING

Appliance error codes

The tumble drier indicates error codes to help locate minor operating faults and identify their cause. The ERROR CODES help locate and determine the cause.

Detected errors are indicated as shown in the following table:

Display indication	Reason	Solution
 is flashing	Water container is full	Empty the container
	Water pump failure or water level sensor error	If the problem persists, contact the SERVICE.
E32	Humidity sensor failure	
E33	Temperature sensor failure	

When an error occurs, the appliance beeps (if active).

MAINTENANCE AND CLEANING

I. Empty the water container

1. Pull out the water container with your both hands;
2. Pour the condensed water into the sink;
3. Replace the water container.

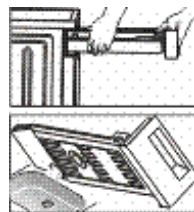

WARNING:

1. Empty the water after each use. If the container becomes full during the drying cycle, programme will be stopped and [] icon will flash. After emptying the container, you can restart the dryer by pressing [Start / Pause].
2. Do not drink the condensation water.
3. Do not use the dryer without water container in place.

II. Clean the top filter

1. Open the door.
2. Remove the top filter
3. Remove fibres and yarn collected on the filter mesh.
4. Replace the top filter

III. Clean the bottom filter

1. Open the filter cover.
2. Unscrew the two locking levers.
3. Pull out the filter body
4. Completely clean the filter mesh.
5. Replace the filter body!
6. Tighten both locking levers.
7. Close the filter cover.

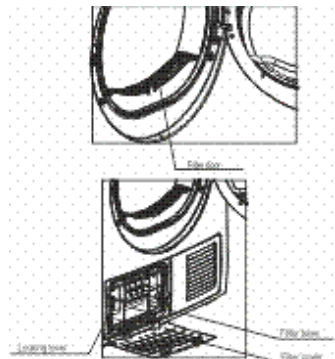

CAUTION!

1. Fluff, threads, fibres collected on the filter block the air flow and thus extend the drying time and increase the energy consumption;
2. Remove the plug from wall outlet before cleaning!
3. Do not operate the dryer without the filter!
4. Clean the filter after each use to prevent the accumulation of fluff, threads, fibres inside the drum.

IV. Clean the heat exchanger

About every two months or when necessary, use a sponge or a soft brush to remove fluff, threads and fibres from the heat exchanger.
Wear gloves when cleaning.

Note: Fluff, threads and fibres can be removed easily when sprayed with water

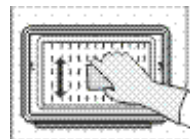

SPECIFICATION

-Type	ADH 82 LCW
-Rated voltage	220-240V / ~ 50Hz.
-Rated power	650 W
- Refrigerant	R134a
- Ambient temperature	+ 5°C ~+ 35°C
- Maximum Load	max 8 kg
- Dimensions Height x Depth x Width	845/595/622 [mm]
- Weight	52 kg
Meets the requirements of EU legislation, EN- 61121 standard	
Contains fluorinated greenhouse gases covered by the Kyoto Protocol Hermetically sealed	

Note:

1. Rated load is a maximum load. Always make sure that the weight of laundry in the dryer never exceeds the rated load.
2. Do not install the tumble dryer in a room where there is a risk of freezing temperature. The dryer may not work properly at temperature close to freezing.
3. Risk of damage if the condensed water freezes in the pump, hose or condensed water container.

Testing for label information in accordance with EN 61121 using the standard cotton drying programmes:

- at full load

- at partial load

- weighted average electricity consumption is **236** kWh/year

Amica

○ Service Help Line

For the UK: please call

0844 815 8880 (non-geographic number)
or **01563 557158** (standard rate call)

For Ireland: please call

0818 46 46 46 (non-geographic number)
or **01 842 8222** (standard rate call)

PRODUCT SHEET

(In accordance with Commission Delegated Regulation (EU) No. 392/2012 of 1 March 2012 supplementing Directive 2010/30/EU of the European Parliament and of the Council with regard to energy labelling of household tumble dryers).

Supplier's name or trade mark	Amica
Type	ADH 82 LCW
Rated load	8.0 kg
Energy efficiency class ¹⁾²⁾	A++
Dryer Type	condensing with heat pump
Annual weighted average energy consumption AE_c ³⁾	236 kWh / year
Energy consumption of the standard cotton drying programme:	
- At full load E_{dry}	1.98 kWh
- At partial load $E_{dry1/2}$	1.08 kWh
Power consumption in the off-mode P_o	0.01 W
Power consumption in standby mode P_l	0.6 W
Duration of the left-on mode:	10 min
Condensation efficiency class on a scale from G (lowest efficiency) to A (highest efficiency) ¹⁾	B
The average condensation efficiency in the standard cotton programme at full load C_t	80%
The average condensation efficiency for the standard cotton programme at partial load C_{dry}	80%
The weighted condensation efficiency for the standard cotton programme at full and partial load $C_{dry1/2}$	80%
The weighted duration of the standard cotton programme at full and partial load T_t	149 min.
Duration of the standard cotton programme at full load T_{dry}	195 min.
Duration of the standard cotton programme at partial load $T_{dry1/2}$	115 min.
Sound level in the standard cotton program at full load L_{wa}	69 dB (A) re 1 pW
Equipment designed for fitting	No
Automatic tumble dryer	No

¹⁾ Energy efficiency class on a scale from A+++ (more efficient) to D (least efficient)

²⁾ "Standard cotton drying programme" is the programme referred to on label and in the datasheet — it is suitable for drying cotton at normal humidity levels and is the most energy efficient programme for drying cotton.

This programme is suitable for drying normal, wet cotton products.

It is the most energy efficient cotton drying programme.

³⁾ Estimated weighted annual energy consumption based on 160 standard cotton drying cycles at full and partial load and power consumption in standby and off modes.

Actual energy consumption depends on how the appliance is used.

The dryer is equipped with a power management system. Standby time 1 minute.

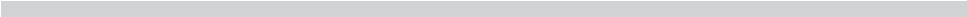



Amica

 Service Help Line

For the UK: please call
0844 815 8880 (non-geographic number)
or **01563 557158** (standard rate call)

For Ireland: please call
0818 46 46 46 (non-geographic number)
or **01 842 8222** (standard rate call)