

Amica

**OPERATING
INSTRUCTIONS
EN**

ADF610WH



ONLY USE THE APPLIANCE WHEN YOU
HAVE READ AND UNDERSTAND
THE OPERATING INSTRUCTIONS

IO-DWS-2103
(01.2022/1)

A decorative horizontal band at the top of the page, featuring a repeating pattern of light gray kitchen icons such as a wok, a spatula, a whisk, and a pot. The word "CONTENTS" is centered in large, bold, black capital letters.

CONTENTS

WE ARE ENVIRONMENTALLY FRIENDLY	3
BASIC INFORMATION	5
SAFETY INSTRUCTIONS	6
INSTALL THE APPLIANCE	13
DESCRIPTION OF THE APPLIANCE	16
CLEANING AND MAINTENANCE	32

WE ARE ENVIRONMENTALLY FRIENDLY

For many years, Amica has consistently pursued pro-ecological policy. Concern for the environment is as important for us as the use of modern technology.

The development of technology has enabled our factories to become more environmentally friendly – we use less and less water, electricity and less waste water and solid waste is generated in the production.

A lot of attention is paid to materials used in production. We strive to use only those that do not contain harmful substances and make recycling and safe disposal possible after use.

Dear customer!

Thank you for choosing an Amica product. For years we have delivered high-quality appliances, so that household chores become a real pleasure. Before being packaged and leaving the manufacturer, this appliance was thoroughly checked with regard to safety and functionality. We also endeavour to make sure that modern technology in Amica products always goes hand in hand with a unique design.

Before using the appliance, please carefully read these Operating Instructions. Follow these instructions to avoid improper use and ensure long and reliable operation of the appliance. Learn the principles of the safe use to avoid accidents.

Store these operating instructions in a safe place to use them for reference whenever needed. These Operating Instructions contain all the necessary information that will make the use of your Amica appliance simple and fun. We also encourage you to find out more about other Amica appliances.

We hope using your new appliance is a pleasure.

Amica

BASIC INFORMATION

Carefully read the operating instructions before plugging dishwasher to a power outlet and using the appliance. Operating instruction include tips that will help you avoid the risk of injury and damage to the appliance. Keep dishwasher documentation in a safe place for possible future use.

These operating instructions have been prepared for a range of appliances and some features described herein may not apply to your appliance.

MANUFACTURER'S DECLARATION

This appliance has been manufactured to comply with all EU & UK statutory requirements and complies with all applicable legislation and the following European Directives:

- The Low Voltage Directive **2014/35/EU**
- Electromagnetic Compatibility Directive **2014/30/EU**
- ErP Directive **2009/125/EC**
- Directive RoHS **2011/65/EC**

The product has been marked with the **UK**
CA and **CE** symbols.

Before you install the appliance	Check the appliance for transport damage. Never install or use a damaged appliance. If in doubt, contact your seller.
Before first use	See installation notes (below).
	Refer the grounding system installation to a qualified electrician.
	The manufacturer shall not be liable for any damage arising from the use of a non-grounded appliance.
	Before using the appliance, verify that the data given on the rating plate matches that of local power outlets.
	Do not plug in the appliance before and during installation.
	Always use the original plug that came with the appliance.
	Do not use an extension cord to connect the appliance to the wall outlet. Extension cords are not sufficiently safe (e.g. they may overheat).
	Make sure the plug is easily accessible after installing the appliance.

Before first use	<p>This appliance can be used by children aged 8 years and older or persons with physical, mental or sensory handicaps, or those who are inexperienced or unfamiliar with the appliance, provided they are supervised or have been instructed how to safely use the appliance and are familiar with the associated risks. Ensure that children do not play with the appliance. Children should not be allowed to clean or maintain the appliance.</p>
	<p>Children less than 3 years of age shall be kept away unless continuously supervised.</p>
Child safety	<p>Do not allow children to play with the appliance.</p>
	<p>Dishwashing detergents can be caustic and irritate the eyes, mouth and throat. Read the safety notes from detergent manufacturer.</p>
	<p>Never leave children unsupervised when the appliance is open. It can contain residue detergent.</p>

Child safety	Dishwasher water is not suitable for drinking. Danger of injury from the caustic chemicals.
	When you open the door during a programme, be careful as water temperature is high.
	To avoid injury always place long and sharp/pointed items (e.g. forks, knives) in the cutlery basket, pointing down, or flat on the top basket.
Daily maintenance	Use the appliance for household dishwashing only.
	Do not use solvents in the appliance as there is a risk of explosion.
	Do not sit or stand on the open door and do not place any objects on it. The device may overturn.
	Do not open the door when the appliance is operating. Hot water or steam can be released.
	Do not leave the door open, because they it can pose a hazard.
	Washing tableware in a household dishwasher usually uses less energy and water than washing up by hand.

In case of problems	Refer repair and modifications of the appliance to qualified technicians only.
	In the event of problems or repairs, unplug the appliance from the wall outlet:
	Unplug the appliance by pulling the plug,
	Turn off the circuit breaker.
	Do not pull the power cord, pull the plug only. Close the water supply.
Recommendations	Loading the dishwasher to the capacity indicated by the manufacturer will save energy and water.
	To save energy and water, rinse food residue of the dishes before loading the dishes into the dishwasher. Run the dishwasher with full load.
	Do not put dishes with food leftovers in the appliance.
	Use pre-wash programme only when needed.
	Load bowls, cups and mugs bottom facing up.
	Do not load in the appliance any dishes that are not dishwasher safe and do not load too many dishes.
	It is not recommended to pre-rinse the tableware, as this leads to an increase in water and energy consumption.

Dishes and utensils that are not suitable for dishwashers.

Ashtrays, candles, cleaning pastes, paints, chemicals, ferro-alloys;

Forks, spoons and knives with a handle made of wood, ivory or Nacre, glued items, items contaminated with abrasive powders, acid or base

Plastic dishes that are not resistant to high temperature, containers made of copper or tin;

Aluminium and silver items (may be stained or loose lustre)

Some delicate types of glass, porcelain with decorative prints, as prints may fade even after the first wash; some crystal dishes as they may lose their transparency, glued silverware sensitive to high temperatures, lead crystal glass, chopping boards, items made with synthetic fibres;

Absorbent objects such as a sponge or kitchen cloths are not suitable for the dishwasher.

Before buying dishes in the future make sure they are dishwasher safe.

DISPOSAL OF OLD APPLIANCE



In accordance with European Directive 2012/19/EU and local legislation regarding used electrical and electronic goods, this appliance is marked with the symbol of the crossed-out waste container. This marking indicates that the appliance must not be disposed of together with other household waste after it has been used.

The user is obliged to hand it over to waste collection centre collecting used electrical and electronic goods. The collectors, including local collection points, shops and local authority departments provide recycling schemes.

Proper handling of used electrical and electronic goods helps avoid environmental and health hazards resulting from the presence of dangerous components and the inappropriate storage and processing of such goods.

UNPACKING

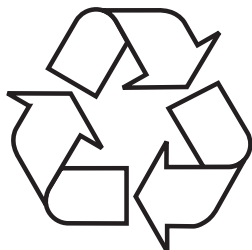

During transportation, protective packaging was used to protect the appliance against any damage. After unpacking, please dispose of all elements of packaging in a way that will not cause damage to the environment.

All materials used for packaging the appliance are environmentally friendly; they are 100% recyclable and are marked with the appropriate symbol.

Important! Packaging materials (bags, polyethylene, polystyrene, etc.) should be kept away from children during unpacking.

INSTALL THE APPLIANCE

PLACE YOUR APPLIANCE

- When choosing the place of installation, make sure you will be able to easily load and remove dishes and utensils from the dishwasher.
- Do not place the appliance in a room where the temperature can fall below 0°C.
- Before installing unpack the appliance following the instructions on the packaging.
- When you move the appliance do not handle it by the door or control panel.
- Leave some room on all sides to have convenient access to the dishwasher when cleaning.
- Make sure that when you set the dishwasher you do not crush the water supply and drain hose. Also, make sure that the appliance is not placed on the power cord.
- Level the appliance using the adjustable legs. Proper level ensures trouble-free opening and closing the dishwasher doors.
- If the dishwasher door will not close properly, check that the appliance stands firmly on the floor, if not, adjust using the adjustable legs.

WATER SUPPLY CONNECTION

Make sure that domestic water supply system is suitable for the dishwasher. It is recommended to install a filter in the water supply line to avoid damage to the appliance due to impurities (such as sand, clay, rust, etc.) that occasionally occur in water. This will also prevent accumulation of sediment after dishwashing.

WATER SUPPLY HOSE

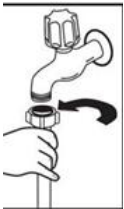

Do not use the water supply hose from the old dishwasher. Use the new water supply hose provided with the appliance. Before connecting, rinse the hose with water. Connect the water supply hose directly to the water feed valve. The domestic water system pressure should be at least 0.03 MPa and up to 1 MPa. If the water pressure exceeds 1 MPa, install pressure reducing valve.

When the connection is ready, open the valve completely and check for leaks. For safety reasons, close the water supply tap after every wash.



NOTE: Aquastop water supply is used in some dishwasher models. Dangerous voltage could occur with Aquastop. Do not cut the Aquastop water supply. Do not allow it to bend or twist

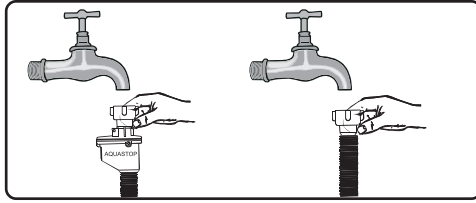

Note:
For safety reasons, close the water tap after every wash

THE DRAIN HOSE

The drain hose can be connected directly to a water drain or kitchen sink stub pipe. You can also drain the water directly into the sink using the special bracket (if available), placing the drain hose outlet on the kitchen sink edge. The drain hose connection should be made at least 50 cm and up to 110 cm from the floor.

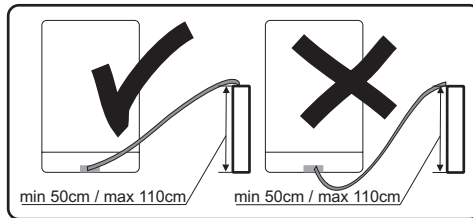

If the drain hose is longer than 4 m, dishes may not be washed properly. The manufacturer will not be held responsible.

ELECTRICAL CONNECTION

Grounded plug must be connected to a grounded power outlet with a proper voltage. If there is no grounding, refer this to a qualified electrician. If you operate the appliance without proper grounding, the manufacturer does not assume any liability for the possible resulting damage.



Domestic electrical system must be protected with a 10-16A fuse.
The appliance must be supplied with 220-240 V AC. If the supply voltage is 110 V, use 3000W, 110/220 V set-up transformer to connect the appliance. Do not connect the appliance during installation.



Always use the plug provided with the appliance. When you operate the appliance at lower voltage the dishwashing efficiency will deteriorate and may damage the appliance.

The power cord may only be replaced by authorized service or a qualified electrician. Failure to comply with these rules may lead to an accident.

For safety reasons, you should always unplug the appliance after you have finished using it.

In order not to avoid electric shock, do not remove the plug from the wall outlet with wet hands.

When you unplug the appliance from the wall outlet, always pull the plug. Never pull the power cord.

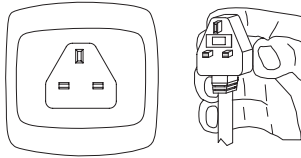

FEATURES AND COMPONENTS

DESCRIPTION OF THE APPLIANCE

The features and components of the appliance (fig. 1):

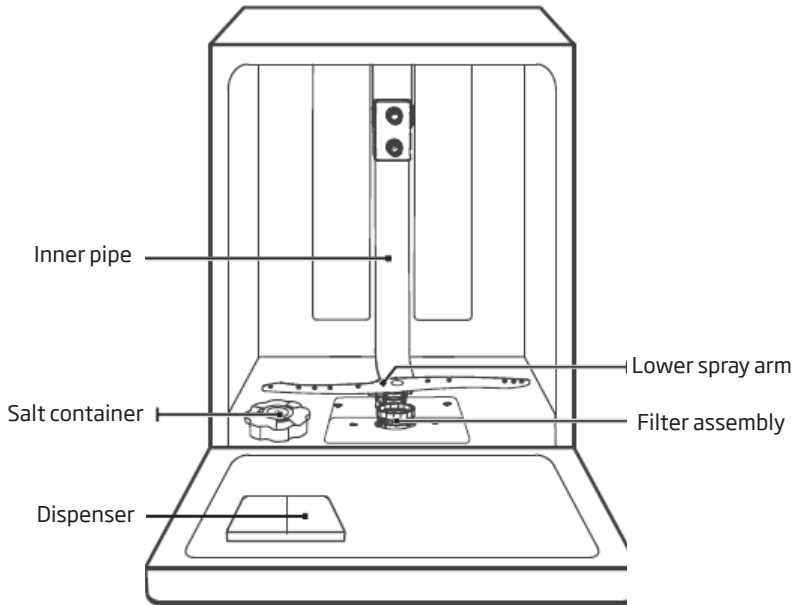

Cutlery basket

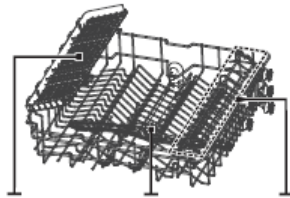

Cutlery rack

Upper spray arm

Upper basket



Cup rack

Lower basket



NOTE:

Figures are for illustrative purposes only Individual models may vary.

* on selected models: When you open the dishwasher door, the interior light will turn on automatically. The appliance interior is well lit.

DISPLAY AND CONTROL PANEL

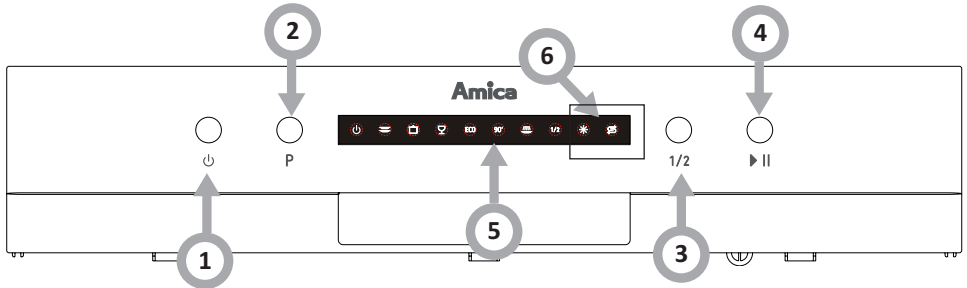



Operation (Button)	
1. Power	Press this button to turn on your dishwasher, the screen lights up. When pressing this button, corresponding indicator will be lit.
2. Program	Select the appropriate washing program, the selected program indicator will be lit.
3. Half load	When you have about or less than 6 place setting dishware to wash, you can choose this function to save energy and water. (It can only be used with Intensive, Universal, Glass ,ECO and 90 min.).
4. Start / Pause	To start the selected washing program or pause it when the dishwasher is working.



NOTE:

Figures are for illustrative purposes only Individual models may vary.

<p>5. Program indicator</p>	<p>Intensive Heavily soiled items include pots and pans. With dried on food.</p> <p>Universal For normally soiled loads, such as pots, plates, glasses and lightly soiled pans.</p> <p>ECO This is the standard program suitable for normally soiled loads, such as pots, plates, glasses and lightly soiled pans.</p> <p>Glass For lightly soiled crockery and glass.</p> <p>90 min For normally soiled loads that need quick wash.</p> <p>Soak For rinsing dishes to be washed later during the day.</p>
<p>6. Warning indicator</p>	<p>Rinse aid If the  indicator is lit, it means the dishwasher is low on dishwasher rinse aid and requires a refill.</p> <p>Salt If the  indicator is lit, it means the dishwasher is low on dishwasher salt and needs to be refilled.</p>

PREPARE THE APPLIANCE FOR OPERATION

1

Before first use

- Before using the appliance, verify that the data given on the rating plate matches that of local power outlets.
- Remove all packing materials from inside of the appliance.
- Prepare special salt (water softener).
- Pour water into the special salt dispenser and then add about 1.5 kg of special salt (dishwasher salt).
- Pour rinse aid into the dispenser.

2

The importance of water descaling

A dishwasher requires soft water (with low calcium content) to operate efficiently. Otherwise, white residue may remain on the dishes and inside the appliance. This has a negative impact on the quality of dishwashing, rinsing and drying. When the water flows through the softener, ions responsible for the water hardness are removed, and the water becomes soft, for best dishwashing results. Depending on the degree of water hardness, the ions responsible for water hardness accumulate quickly inside the water softener. Therefore, the water softener must be regenerated to operate with the same efficiency during the next wash. This is why special salt is used in the dishwasher.

3

Add special salt

Only use special salt intended for dishwashers.

Any other type of salt that is not intended for use in a dishwasher, especially regular kitchen salt, will damage the water softener. In the event of damage caused by the use of the wrong salt, the manufacturer's warranty is void and we will not be liable for damage.

Fill with special salt before running the washing programme.

This will prevent spilled special salt or salty water from remaining on the bottom of the device, which may cause corrosion.

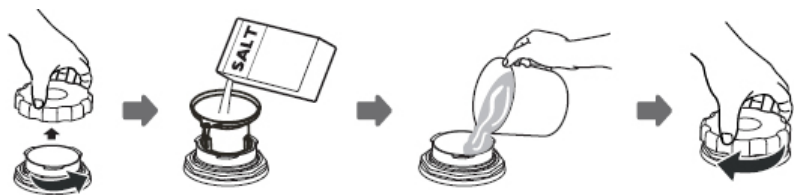

1. Remove the lower basket from the appliance and unscrew the special salt dispenser cap.
2. Place the end of the funnel (included) in the hole and pour about 1.5 kg of salt.
3. Pour water into the dispenser until full. It is normal that a small amount of water spills out of the special salt dispenser.
4. After you fill the dispenser, screw the cap on.
5. When you fill the dispenser with special salt, the add salt indicator goes out.
6. Start the washing programme immediately after filling the dispenser with special salt (the quick wash is recommended). Otherwise, salty water can damage the filters, the pump or other important appliance components. This is not covered by the warranty.

NOTE:





- Fill the special salt dispenser when the  special salt indicator on the control panel lights up. Depending on the rate of salt dissolution, the special salt indicator may still be on even after filling the dispenser. If there is no special salt indicator on the control panel (on some models), you can estimate when to top up the dispenser based on the number of wash cycles performed.
- If some special salt spills, run the soaking programme or a quick wash programme.



Use only the special salt intended for dishwashers!

The test strip

The dishwashing effectiveness is linked to water hardness. Therefore, the appliance is equipped with a system to reduce the hardness of the water supply. The dishwashing effectiveness is improved when the system is set correctly. To check water hardness contact the municipal water company or determined the water hardness using test strip (if available).

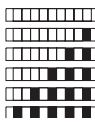
<p>a</p>  <p>Open the test strip package</p>	<p>b 1 min.</p>  <p>Open the water tap for 1 min.</p>	<p>c ↓ 1 second</p>  <p>Immerse the test strip in the water for 1 second</p>	<p>d</p>  <p>Once removed shake off the residual water</p>	<p>e</p>  <p>Wait 1 min.</p>	<p>f</p>  <p>Set the dishwasher water hardness in accordance with the measurement made</p>	<p>Level 1 – no calcium Level 2 – very small calcium content Level 3 – small calcium content Level 4 – medium calcium content Level 5 – high calcium content Level 6 – very high calcium content</p>
---	---	--	--	--	--	---

Fill the detergent dispenser

Open the detergent dispenser flap by pressing the detergent dispenser tab to release the lock as shown in the figure. The detergent dispenser features volume marking. Using these markings (lines) you can measure the correct amount of detergent. The dispenser can accommodate a maximum of 30g of detergent.

Open the pack with dishwasher detergent and in the case of heavily soiled dishes pour 25 cm³ detergent into the main wash compartment (A) or 15 cm³ for less soiled dishes (B). If the dishes remained unwashed for an extended period of time or if food has dried, pour 5 cm³ detergent into the pre-wash compartment and start the dishwasher. Depending on the amount of soil and the water hardness you may need to add more detergent.

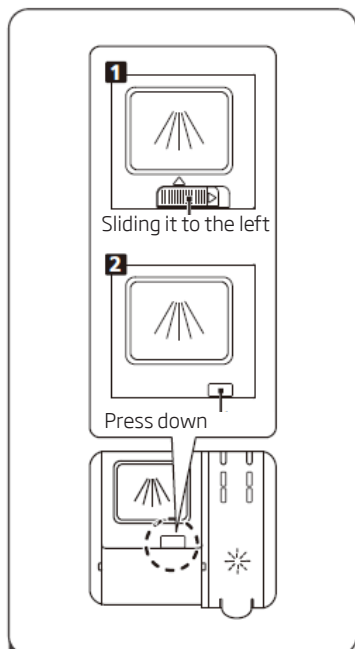

- 1 Please choose an open way according to the actual situation.
1. Open the cap by sliding the release catch.
 2. Open the cap by pressing down the release catch.

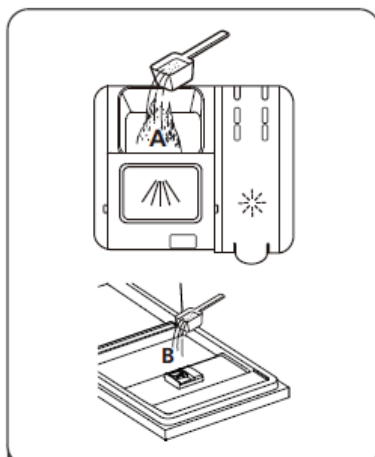

- 2 Add detergent into the larger cavity (A) for the main wash cycle. For better cleaning result, especially if you have very dirt items, pour a small amount of detergent onto the door. The additional detergent will activate during the pre-wash phase.

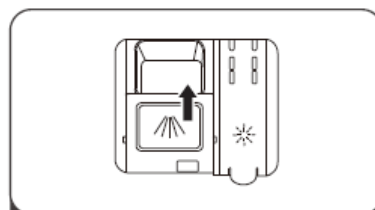

- 3 Close the flap by sliding it to the front and then pressing it down.



Please note that the setting may be different depending on the water contamination. Follow the manufacturer's instructions on the detergent packaging.

Multi-component (multitab) detergents (eg. 2-in-1, 3-in-1, etc.)

There are three types of detergents:

1. Containing phosphates and chlorine,
2. Containing phosphates and no chlorine,
3. Containing no phosphates and no chlorine.

The latest tablets are generally phosphate-free. Since phosphates have water softening properties, we recommend adding salt to the container even if the water hardness is only 6°dH. If you use phosphate-free detergent where water is hard, white residue may be visible on the dishes.

You can prevent this by increasing the amount of detergent. Chlorine-free detergents have less bleaching effect. Stains may not be entirely removed. Select the programme with a higher wash temperature. Generally, using multi-component detergents suitable results are obtained only under certain conditions. Such detergents contain rinse aid and/or special salt in a specific amount. It is recommended to use special salt when using multi-component tablets.

What you should pay attention to when using these tablets.

- Always check the type of detergent used and whether it is a multi-component product.
- Make sure that the detergent used is appropriate for tap water hardness.
- Follow the instructions on the product packaging.
- If the detergent is in the form of tablets, never place it the cutlery basket. Always place the tablet in the detergent dispenser compartment.
- The use of these detergents yields good results only in certain applications. Using this type of detergent you should contact the manufacturer for information about proper use.
- If you use the detergent properly and dishwasher settings are correct you can save on salt and/or rinse aid.
- If dishwashing results while using 2-in-1 or 3-in-1 detergents are not satisfactory (traces of lime scale on the dishes), please contact the detergent manufacturer. The warranty does not cover complaints due to the use of multi-component detergents.



Recommended use: For best results using multi-component cleaning agents, add special salt and rinse aid in the dishwasher and set the water hardness and amount of rinse aid to the lowest setting.

The solubility of the detergent tablets made by different manufacturers can vary with regard to temperature and time. It is therefore not recommended to use detergent tablets in quick programmes. It is recommended to use powder detergents in quick programmes.



Always store detergents in a dry, cool place, out of reach of children. Add detergent to the dispenser immediately before using the appliance.

Warning: If encounter another problem when using a multi-component detergent, please contact the detergent manufacturer.

Stop using multi-component detergents

- Add special salt and rinse aid to dispensers.
- Set the water hardness to the highest level (6) and run an empty dishwasher.
- Adjust the water hardness.
- Adjust rinse aid setting.

8

Add rinse aid to the dispenser and adjust setting

Use rinse aid to prevent the formation of white water drops, lime scale spots, white streaks that may occur on the dishes, as well as to improve the drying process. Contrary to popular belief, it not only serves to obtain a shiny dishes, but also to facilitate drying. For this reason, make sure there is always sufficient amount of rinse aid in the dispenser.

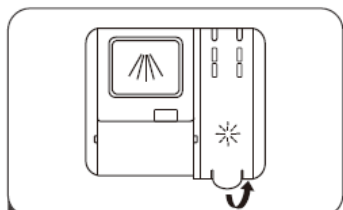

1 Remove the rinse reservoir cap by lifting up the handle.

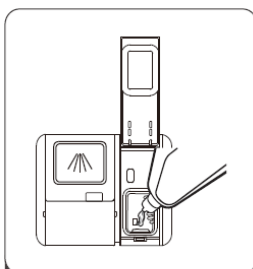

2 Pour the rinse aid into the dispenser, being careful not to overfill.

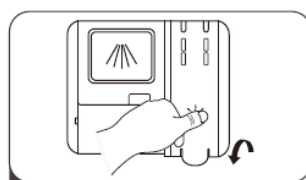

3 Close the cap after all.

Adjusting the rinse aid reservoir

To achieve a better drying performance with limited rinse aid, the dishwasher is designed to adjust the consumption by user. Follow the below steps.

1. Close the door, switch on the appliance.
2. Within 60 seconds after step 1, press the Program button more than 5 seconds, and then press the half load Button to enter the set model, the rinse aid indication blinks as 1Hz frequency.
3. Press the Program button to select the proper set according to your using habits, the sets will change in the following sequence: D1- > D2- > D3- > D4- > D5- > D1, Dispenser drops more rinse aid in D5 level than in another, the manufactory setting is D3.
4. Press the Power button to end the setup model.

Selector position	Amount of rinse aid (mL)
D1-> Soak Light bright	1.2
D2-> 90min Light bright	2.4
D3-> 90min, soak Light bright	3.6
D4-> ECO Light bright	4.8
D5-> eco, soak Light bright	6.0



Warning: Use only rinse aid designed for domestic dishwashers. Wipe up spilled rinse aid with a cloth as it will cause the formation of large amounts of foam, and thus will reduce the dishwashing effectiveness.

Water hardness table

Water hardness	German degrees [dH]	French degrees [dF]	British degrees [dE]	Water hardness level indicator	Special salt consumption [g/cycle]
1	0 ~ 5	0 ~ 9	0 ~ 6	H1-> Soak Light bright	0
2	6-11	10-20	7-14	H2-> 90min Light bright	9
3	12-17	21-30	15-21	H3-> Soak, 90min Light bright	12
4	18-22	31-40	22-28	H4-> Eco Light bright	20
5	23-34	41-60	29-42	H5-> Eco, Soak Light bright	30
6	35-55	61-98	43-69	H6-> 90min, Eco Light bright	60

If the water hardness is higher than the maximum values given in the table above, or if you use water from a deep well, it is recommended to use filters and water treatment equipment.

NOTE: The factory settings are for the water hardness level 3.

1. Close the door. Switch on the appliance;
2. Press the Program button for more than 5 seconds to start the water softener set model within 60seconds after the appliance was switched on;
3. Press the Program button to select the proper set according to your local environment, the sets will change in the following sequence:
H1->H2->H3->H4->H5->H6;
4. Press the Power button to end the set up model.

The use of detergents

Use a detergent for domestic dishwashers. On the market you can find detergent intended for dishwashers in the form of powder, gel and tablets. The detergent must be placed in the dispenser before starting the dishwasher. Store detergent in a cool and dry place, out of reach of children. Do not overfill the detergent dispenser, otherwise the detergent may not dissolve completely and leave streaks on the dishes. If you need more information on the detergent used, please contact the manufacturer directly.

LOAD DISHES INTO DISHWASHER

1

Upper basket

The upper basket is designed for washing delicate dishes such as glasses, cups, plates, etc. Dishes that are placed in the upper basket should be less soiled than dishes in the lower basket.

You can place long forks, knives and spoons horizontally on shelves so as not to obstruct the spray arms.

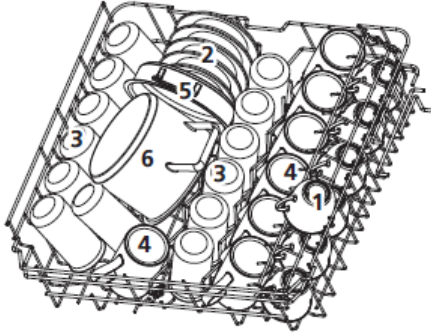

2

Fold the mugs and cups shelves

Fold the shelves to increase the capacity of the upper basket. You can place the glasses and mugs on the shelves. Raise the cup shelf to make more space in the basket for taller items. You can then lean the taller glasses against the shelf. It can also be removed if it is not needed.



3

Fold the dishwasher basket spikes

The spikes are used to hold the plates. They can be folded, making more room for large dishes.

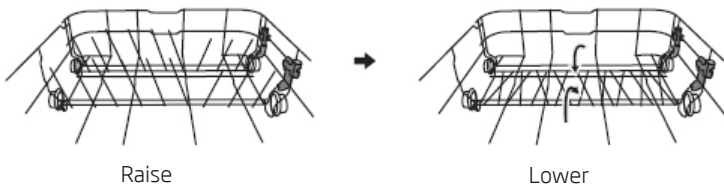

Tips for using the dishwasher basket:**Adjust the upper basket****Type 1:**

The height of the upper basket can be easily adjusted to accommodate tall pots and pans in the upper or lower basket.

To adjust the height of the upper basket:

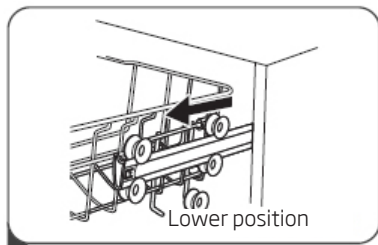

1

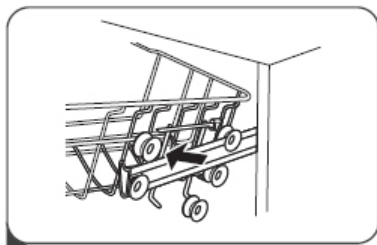

2

1. Extend the upper basket.
2. Remove the upper basket.

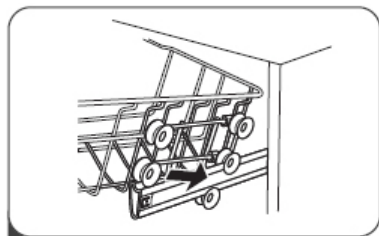

3

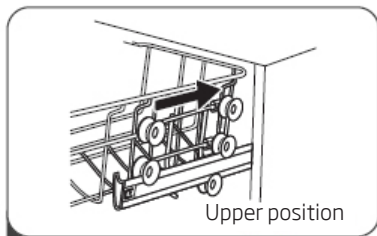

4

3. Mount the basket on the upper or lower rollers.
4. Insert the upper basket.

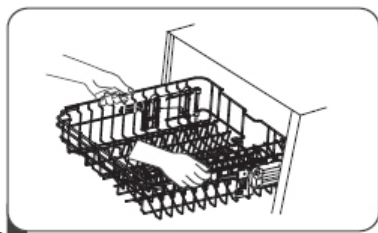
Type 2:

1

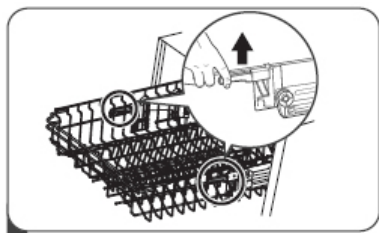

2

1. To raise the basket to the upper position, raise it until it is at the same height on both sides. Make sure it is securely attached to the rails.
2. To lower the basket, push down and release the handles.

5

Lower basket

Put plates, bowls, pots, etc. in the lower basket. Make sure that dishes in the lower basket do not block the spray arm and it can rotate freely. Place large pans and heavily soiled items such as pots, pans, lids, dishes, etc. in the lower basket. Place dishes upside down, so that water does not collect inside.



Place the dishes in such a way that they do not block the spray arm.

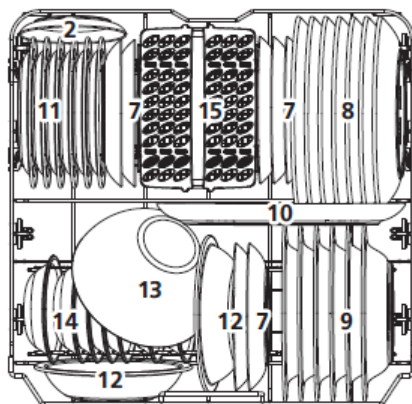

The standard load and test results

Capacity:

The upper and lower basket: 13 place settings. Set the upper basket to the upper position. Place the cups on the shelves.

Detergent/rinse aid

4+17g, in accordance with the EN 60436 international standards/rinse aid dose: 5

Test programme

Eco, in accordance with the EN 60436 international standard

Upper basket

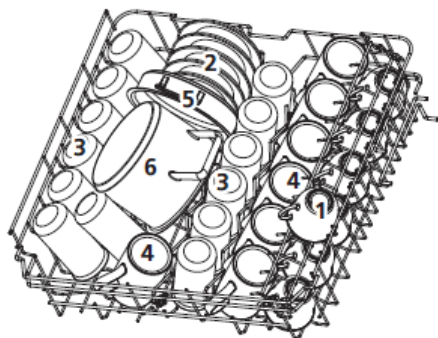

Item	Cookware
1	Cups
2	Saucers
3	Glasses
4	Small salad bowls
5	Medium salad bowls
6	Large salad bowls
7	Dessert plates
8	Dinner plates
9	Soup plates
10	Oval platter
11	Melamine dessert plates
12	Melamine bowls
13	Glass bowl
14	Dessert bowls
15	Cutlery basket

Lower basket

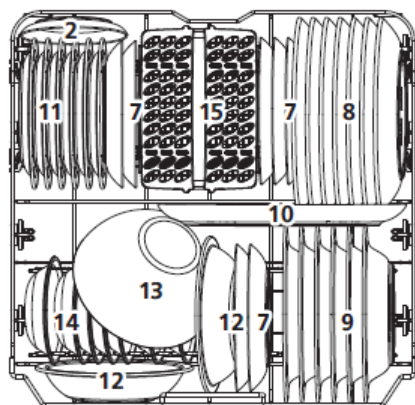

Cutlery rack

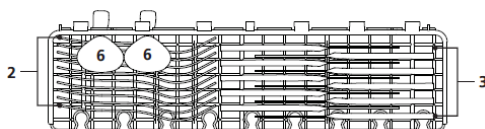

Tests specification according to EN 60436

Capacity – 13 standard place settings

Upper basket setting – lower position

Programme – ECO

Rinse dose setting – 5

Water hardness setting – H3

Cutlery basket

Place knives and forks separately from each other, and make sure they do not touch as this may cause poor washing results.
For best washing results place knives and forks in the cutlery basket, and make sure: they do not touch and place objects in the middle.

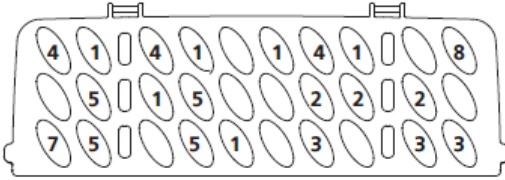

Item	Cutlery
1	Soup spoons
2	Forks
3	Knives
4	Tea spoons
5	Dessert spoons
6	Serving spoons
7	Serving forks
8	Gravy ladles

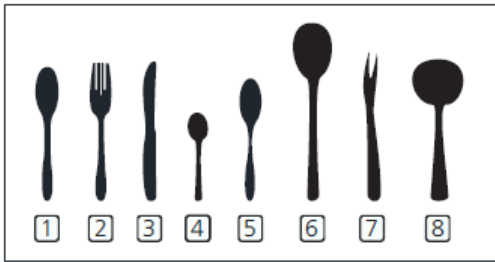

TURN ON THE APPLIANCE AND SELECT PROGRAMME

1

Turn on the appliance

1. Draw out the lower and upper basket, load the dishes and push them back. It is commended to load the lower basket first, then the upper one.
2. Pour in the detergent.
3. Insert the plug into the socket.
Make sure that the water supply is turned on to full pressure.
4. Close the door, press the Power button, to switch on the machine.
5. Choose a program, the response light will turn on. Then press the Start/Pause button, the dishwasher will start its cycle.

2

Change programme

You can change the programme only if it runs for a short time. Otherwise the detergent is already dissolved in water and the water could be pumped out. In this case, refill the dispenser with detergent and start the washing program from the beginning. To reset your dishwasher, please follow the instructions below:

1. Press the Start/Pause button to pause the washing.
2. Press Program button for more than 3 seconds - the program will cancel.
3. Press the Program button to select the desired program.
4. Press the Start/Pause button, after 10 seconds, the dishwasher will start.

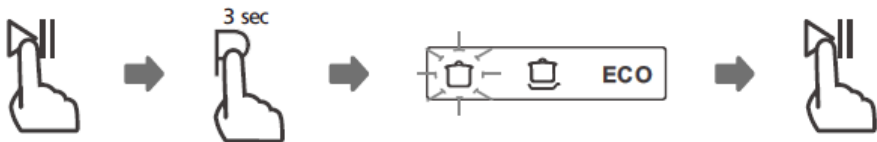

3

Add dishes during the programme:

You can add extra dishes at any time before detergent is released. In this case, follow the instructions below:

1. Press the Start/Pause button to pause the washing.
2. Wait 5 seconds then open the door.
3. Add the forgotten dishes.
4. Close the door.
5. Press the Start/Pause button after 10 seconds, the dishwasher will start.

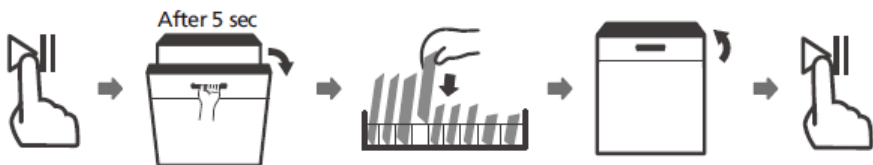

WARNING!

Be careful when opening the door during the dishwashing programme as hot steam can be released and cause scalding.

The dishwashing programme completes

Press on/off button to turn off the appliance. Close water supply tap and open the dishwasher door. Wait a few minutes before unloading the dishwasher. Allow dishes to cool. Hot dishes are more susceptible to breakage. Also the dishes will dry.

Turn off the dishwasher

The programme is completed only when the programme indicator is on, but not flashing.

1. Press On/Off button to turn off the appliance.
2. Close water supply tap!

Open the door carefully.

Hot dishes are more susceptible to breakage. Before unloading the dishwasher leave the dishes to cool for about 15 minutes.

Open the dishwasher door, leave it ajar and wait a few minutes before removing the dishes. This will allow the dishes to cool and dry.

Unload the dishwasher

It is normal that the dishwasher interior is wet.

First remove dishes from the lower basket and then from the upper basket. This will avoid water dripping from the upper basket on the dishes in the lower basket.

1

Clean external surfaces

Door and door seal

To remove food residue, clean the door gasket regularly with a soft, moist cloth. When loading dishes into the dishwasher, food and drink residue may deposit on the sides of the dishwasher door. These surfaces are outside the dishwasher compartment and the water from the spray arms does not reach them. Remove any residue before closing the door.

Control Panel

Wipe the control panel ONLY with a soft, damp cloth.



WARNING

Do NOT use any spray cleaner to prevent water ingress into the door lock and electrical components.

Do not use any abrasive detergents or sharp cleaners on external surfaces. Some paper towels may also leave scratches or marks on the surface.

2

Clean internal surfaces

Filter system

The filter system at the bottom of the dishwasher compartment stops coarse residue during wash cycle. This residue can cause clogging of the filters. Regularly check the condition of the filters and rinse them under running water, if necessary. Clean the filters as follows.



NOTE:

Figures are for illustrative purposes only. Filter systems and spray arms may vary in individual models.

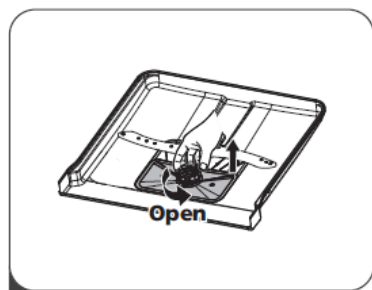

1

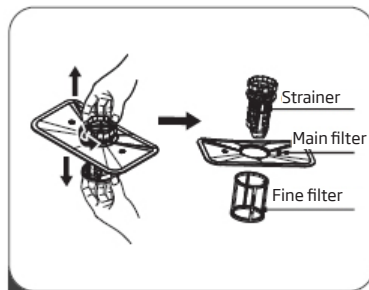

2

1. Hold the strainer and turn it counter clockwise to unscrew. Lift the filter up and remove it from the dishwasher.

2. The fine filter can be removed from the bottom of the filter assembly. The strainer can be disengaged from the main filter by gently squeezing the edges and pulling.

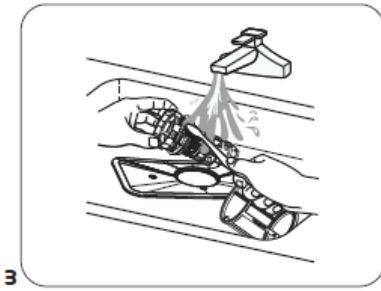

3

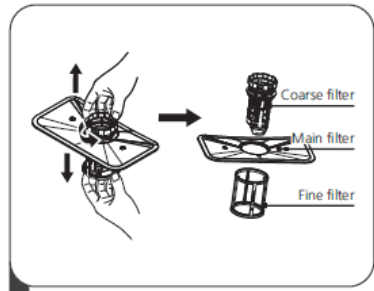

4

3. Larger residues can be rinsed under running water. Clean the filter completely with a soft, clean brush.

4. Install the filters in reverse order, place the filter insert and turn clockwise as indicated by the arrow.



WARNING

Do not overtighten the filters. Carefully replace the filters and install in place. Otherwise, contaminants can enter the dishwasher's systems and cause clogging.

NEVER use the dishwasher without the filter assembly. Incorrect filter replacement can reduce the appliance effectiveness and cause damage to the dishes and cutlery.

3

Spray arms

Clean spray arms regularly. Hard water and detergents can clog the nozzles and the spray arm slide rings.

Clean spray arms:

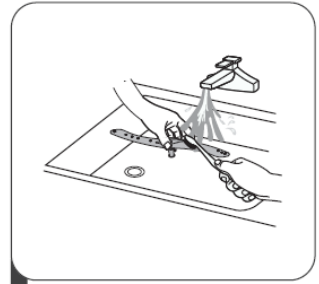
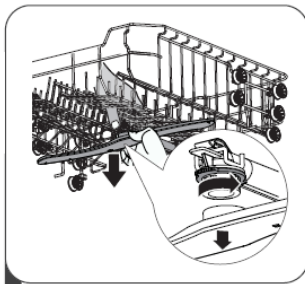

1. To remove the upper spray arm, hold the nut in place and turn the arm counter clockwise.

2. To remove the lower spray arm, pull the arm up.

3. Clean the spray arms with a soft brush in warm soapy water. Rinse the arms and install in the appliance.

Clean the dishwasher

Frost protection

In winter, the dishwasher must be protected against freezing temperature. After each wash:

1. Disconnect the dishwasher from power.
2. Turn off the water supply and disconnect the water inlet hose from the water valve.
3. Drain the water from the inlet hose and the water valve. (Collect the water in a bowl)
4. Reconnect the water inlet hose to the water valve.
5. Remove the filter and use a sponge to collect the water from the bottom of the dishwasher.

After each wash

After each wash, close the water supply to the appliance and leave the door slightly ajar, so that moisture and odours are not trapped inside.

Unplug the appliance

Unplug the appliance from the wall outlet before any cleaning and maintenance.

Do not use solvents or abrasive detergents.

Do not use solvents or abrasive detergents to clean the outer parts and the rubber seals of the dishwasher. Use only cloths and warm soapy water.

To remove stains from the inside use a cloth dampened with water and a little vinegar or cleaning detergent intended specifically for dishwashers.

If the dishwasher is not used for a long time

It is recommended to run the washing programme with an empty dishwasher, then unplug the appliance from power, close the water supply and leave the door slightly ajar. This protects the gaskets and prevents the formation of unpleasant odours in the appliance.

Move the appliance

If the appliance needs to be moved, try to keep it in an upright position. If absolutely unavoidable, you can rest the appliance on the back wall.

ERROR CODES AND TROUBLESHOOTING

In the event of a fault, the dishwasher displays error codes that identify the problem:

ERROR CODE	DESCRIPTION OF THE FAULT	ACTION
The Soak light flicker fleetly	Longer inlet time.	Faucets is not opened, or water intake is restricted, or water pressure is too low.
The Eco light flicker fleetly	Not reaching required temperature.	Malfunction of heating element.
The Soak and 90 min light flicker fleetly	Overflow	Some dishwasher element leaks.
The Eco, Soak and Glass light flicker fleetly	Failure of communication between main PCB with display pcb.	Open circuit or break wiring for the communication.

WARNING!

If overflow occurs, turn off the main water valve before calling for service.

If there is water in the bottom tray due to overflow or a small leak, empty the water before starting the dishwasher.

Problem	Possible cause	Solution
The dishwasher will not start	The dishwasher will not start	The dishwasher door is open – close the door.
	The appliance is not connected to the mains power The Delay start function is selected	Close the door carefully, make sure it is closed fully
	Child Lock is enabled (selected models)	Turn off the Child Lock
The dishwasher beeps at the end of the wash cycle	It indicates the end of the wash programme and emits a beep	
The rinse aid indicator is on	The LED display shows "Lsb"	Add rinse aid
The wash cycle takes too long	The dishwasher is connected to hot water	Check the dishwasher, make sure it is properly connected to hot water
	The duration of the wash programme varies depending on how soiled the dishes are	When heavy soil is detected, auto and normal programmes, automatically extend the wash cycle duration
	The disinfection option has been selected	When you select the disinfection option, the wash cycle time will be extended to reach the disinfection temperature
The dishes are not clean enough	The water pressure is temporarily low	Use a dishwasher when the pressure is normal
	The temperature of the inlet water is low	Ensure that the dishwasher is connected to hot water. Try not to use the dishwasher if hot water is used elsewhere in the household
	The dishes are arranged too close together. The detergent is used incorrectly	Rearrange the dishes in accordance with the instructions. Use the amount of detergent suitable for the water hardness and the selected wash programme. Use a new/different detergent
	The selected wash programme is not suitable for the level of soil on the dishes	Select a different, more intensive/longer wash programme
	The spray arm rotation is blocked	Make sure that the spray arm rotates freely

Problem	Possible cause	Solution
The dishwasher will not start	The dishwasher will not start	Close the door carefully, make sure it is closed fully
	The appliance is not connected to the mains power The Delay start function is selected	Check the connection to the power supply To change the setting, refer to the Start Delay section in the operating instructions
	Child Lock is enabled (selected models)	Deactivate the Child Lock function, refer to the Child Lock section in the operating instructions.
The dishes are not dry enough	The detergent dispenser is empty	Fill the rinse aid dispenser or increase the dispensed amount
	Dishes placed incorrectly in the dishwasher	Rearrange the dishes in accordance with the instructions.
	The selected programme dose not include the drying stage	Select the wash program that includes drying
Stains and deposits on dishes	Water too hard	In the case of very hard water, a water softener should be installed
	Dishes placed incorrectly in the dishwasher	Rearrange the dishes in accordance with the instructions.
	An old rinse aid was used	Use new rinse aid
	Rinse aid dispenser is empty	Add rinse aid to the dispenser
	Too much detergent	Use less detergent if water is soft
	The temperature of water supplied to the dishwasher exceeds 70°C	Reduce the temperature of the water supply
The detergent was not fully released from the dispenser	The detergent may be too old	Use a new/different detergent
	The spray arm rotation is blocked	Rearrange the dishes making sure that the spray arm rotation is not restricted
The detergent dispenser will not close	The lid of the detergent dispenser is malfunctioning	Add detergent and rinse aid according to the instructions
The water was not drained from the dishwasher	The previous programme was not completed or was interrupted	For information on how to select a suitable wash programme, please refer to the operating instructions
	Food residue or glass shards clogged the pump.	Remove foreign body.

Problem	Possible cause	Solution
The dishwasher does drain the water properly	The drain is clogged	Check the air trap.
	The drain hose is bent	Make sure that the drain hose is correctly connected to the drain
Foam in the dishwasher	The wrong detergent was used	Make sure that the detergent used is suitable for dishwashers
The dishwasher is leaking	The use of the wrong detergent resulted in a deposit	Make sure that the detergent used is suitable for dishwashers
	The dishwasher is not levelled	Level the dishwasher
Black or grey streaks on the dishes	The aluminium dishes rubbed against the plates.	Rearrange the dishes
The interior of the dishwasher is stained	Coffee and tea grounds	Use a certified stain removal agent
	A reddish stain	Load the dishes and run the rinsing programme which will reduce the stain formation
Noise	Noise of the detergent dispenser lid opening or water drain pump operating	This is normal.
	A hard object in the dishwasher's system. When the object drops to bottom, the noise should stop	If the noise continues after the full wash cycle, call service.
The appliance does not fill with water	The water tap is shut off	Check that the water tap is open
	The door lock may not be engaged	Make sure that the door is closed.

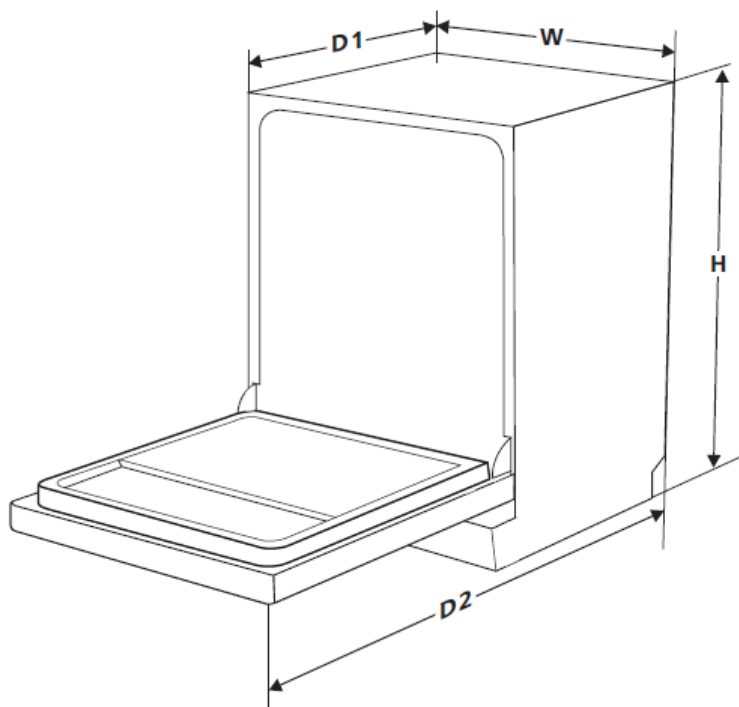

Height [mm] [H]	845 mm
Width [mm] [W]	598 mm
Depth [mm] [D1]	600 mm (with doors closed)
Depth [mm] [D2]	1175 mm (with 90° doors open)



Amica

○ Service Help Line

For the UK: please call
01949 862012

For Ireland: please call
0818 46 46 46 (non-geographic number)
or **01 88 2010** (standard rate call)